

# CITY AND COUNTY BOND PROPOSITIONS AND CHARTER AMENDMENTS

To Be Voted on at Election to Be Held  
NOVEMBER 7, 1944



Published under provisions of Section 183 of the  
Charter of the City and County of San Francisco.

*Cameron H. King*

Registrar of Voters.

---

## CONTENTS

### BOND PROPOSITIONS

	Page
No. 26—Sewer Construction and Reconstruction Bonds.....	2
No. 27—Juvenile Home and Court Bonds.....	4

### CHARTER AMENDMENTS

	Page
No. 28—Retired Persons in Employments—Pensions.....	7
No. 29—Secretary, Superintendent of Schools.....	8
No. 30—Steinhart Aquarium—Employees .....	9
No. 31—Recreation Commission—Term of Office.....	10
No. 32—City Attorney and Public Defender—Employees.....	11
No. 33—Reinstatement After Red Cross Service.....	12
No. 34—Police Department—Retirement .....	14

## PROPOSITION No. 26

**SEWER BONDS, 1944. To incur a bonded indebtedness in the sum of \$12,000,000 for constructing new and reconstructing old sewers, and sewage disposal plants, within the city and county.**

Bill No. 3039, Ordinance No. 2871 (Series of 1939):

Calling and providing for a special election to be held in the City and County of San Francisco on Tuesday, November 7, 1944, for the purpose of submitting to the voters of the City and County of San Francisco a proposition to incur a bonded debt of the City and County to the amount of \$12,000,000 for the construction of new sewers, replacement of sewers insufficient in size, replacement of worn-out sewers, sewage treatment works and sewage pumping stations, within the City and County of San Francisco, together with all appurtenances and lands that may be necessary for the purposes stated, fixing payment of interest of said bonds and prescribing notice to be given of such election.

Be it ordained by the People of the City and County of San Francisco, as follows:

Section 1. A special election is hereby called and ordered to be held in the City and County of San Francisco on Tuesday, the 7th day of November, 1944, for the purpose of submitting to the electors of said city and county a proposition to incur a bonded indebtedness of the City and County of San Francisco in the principal amount of \$12,000,000 for the acquisition, construction and completion of the following municipal improvement, to-wit: Construction of new sewers, replacement of sewers insufficient in size, replacement of worn-out sewers, sewage treatment works and sewage pumping stations, within the City and County of San Francisco, together with all appurtenances and lands that may be necessary for the purposes stated.

Section 2. The estimated cost of the municipal improvement described herein was fixed by the Board of Supervisors by Resolution No. 4157 (Series of 1939), passed by more than two-thirds of said board, and approved by the Mayor in the sum of \$12,000,000, and such sum is too great to be paid out of the ordinary annual income and revenue of the city and county in addition to the other annual expenses thereof or other funds derived from taxes levied for that purpose.

The method and manner of payment of the estimated cost of the municipal improvement described herein are, by the issuance of bonds of the City and County of San Francisco in the principal amount specified in Section 1 hereof.

Section 3. The special election hereby called and ordered to be held shall be held and conducted and the votes thereat received and canvassed, and the returns thereof made and the result thereof ascertained, determined and declared as herein provided and in all particulars not herein recited said election shall be held according to the laws of the State of California providing for and governing elections in the City and County of San Francisco, and the polls for such election shall be and remain open during the time required by said laws.

Section 4. The said special election hereby called shall be and hereby is consolidated with the General Election to be held Tuesday, November 7, 1944, and the voting precincts, polling places and officers of election for said General Election be and the same are hereby adopted, established, designated

and named, respectively, as the voting precincts, polling places and officers of election for said special election hereby called, and as specifically set forth by the Registrar of Voters of polling places and election officers for the said General Election.

The ballots to be used at said special election shall be the ballots to be used at said General Election.

Section 5. On the ballots to be used at such special election and on the voting machines used at said special election, in addition to any other matter required by law to be printed thereon, shall appear thereon the following:

"Sewer Bonds, 1944. To incur a bonded indebtedness in the sum of \$12,000,000 for constructing new and reconstructing old sewers, and sewage disposal plants, within the city and county."

To vote for the proposition where ballots are used, and to incur the bonded indebtedness to the amount of and for the purposes stated herein, stamp a cross (X) in the blank space to the right of the word "Yes." To vote against the proposition and thereby refuse to authorize the incurring of a bonded indebtedness to the amount of and for the purposes stated herein, stamp a cross (X) in the blank space to the right of the word "No."

Where voting machines are used at said special election the said voting machines shall be so arranged that any qualified elector may vote for the proposition by pulling down a lever over the word "Yes" under or near a statement of the proposed proposition appearing on cardboard, paper or other material placed on the front of the machine, and said act shall constitute a vote for the proposition, and by pulling down a lever over the word "No" under or near a statement of the proposed proposition appearing on cardboard, paper or other material placed on the front of the machine, shall constitute a vote against the proposition. Said voting machines and the preparation of the same shall comply in all respects with the provisions of law.

Section 6. If at such special election it shall appear that two-thirds of all the voters voting on said proposition voted in favor of and authorized the incurring of a bonded indebtedness for the purposes set forth in said proposition, then such proposition shall have been accepted by the electors, and bonds shall be issued to defray the cost of the municipal improvement, other properties and structures described herein. Such bonds shall be of the form and character known as "serials," and shall bear interest at a rate not to exceed 6 per centum per annum, payable semi-annually.

Section 7. For the purpose of paying the principal and interest on said bonds, the Board of Supervisors shall, at the time of fixing the general tax levy and in the manner for such general tax levy provided levy and collect annually each year until such bonds are paid, or until there be a sum in the Treasury of said City and County set apart for that purpose to meet all sums coming due for the principal and interest on said bonds, a tax sufficient to pay the annual interest on such bonds as the same become due and also such part of the principal thereof as shall become due before the proceeds of a tax levied at the time for making the next general tax levy can be made available for the payment of such principal.

Section 8. This ordinance shall be published once a day for at least seven (7) days in the San Francisco Chronicle, a newspaper published daily in the City and County of San Francisco, being the official newspaper of said City and County and such publication shall constitute notice of said election and no other notice of the election hereby called need be given.

**Read Second Time and Finally Passed—Board of Supervisors, San Francisco, August 28, 1944.**

**Ayes:** Supervisors Brown, Gallagher, Gartland, Green, MacPhee, Mancuso, Mead, Meyer, Sullivan, Uhl.

**Absent:** Supervisor Colman.

I hereby certify that the foregoing ordinance was finally passed by the Board of Supervisors of the City and County of San Francisco.

DAVID A. BARRY,  
Clerk.

Approved, San Francisco, August 30, 1944.

DAN GALLAGHER,  
Acting Mayor.

## **PROPOSITION No. 27**

**JUVENILE HOME AND COURT BONDS, 1944. To incur a bonded indebtedness in the sum of \$1,250,000 for the construction of buildings for uses of a Juvenile Detention Home, with meeting, court rooms and offices and the necessary lands therefor.**

Bill No. 3038, Ordinance No. 2870 (Series of 1939):

Calling and providing for a special election to be held in the City and County of San Francisco on Tuesday, November 7, 1944, for the purpose of submitting to the voters of the City and County of San Francisco a proposition to incur a bonded indebtedness of the City and County to the amount of \$1,250,000 for the acquisition, construction and completion by the City and County of San Francisco of the following municipal improvement, to wit: A building or buildings within the City and County of San Francisco adequate for uses of a Juvenile Detention Home, with court rooms, meeting rooms, and offices for the accommodation of those connected with the Juvenile Court, Juvenile Detention Home, contained therein, the necessary furnishings and equipment for said building or buildings and all appurtenances for the use and operation of said building or buildings as a Juvenile Detention Home, and the necessary lands for said buildings, fixing payment of interest and retirement of said bonds and prescribing notice to be given of such election.

Be it ordained by the People of the City and County of San Francisco, as follows:

Section 1. A special election is hereby called and ordered to be held in the City and County of San Francisco on Tuesday, the 7th day of November, 1944, for the purpose of submitting to the electors of said City and County a proposition to incur a bonded indebtedness of the City and County of San Francisco in the principal amount of \$1,250,000 for the acquisition, construction and completion by the City and County of San Francisco of the following municipal improvement, to wit: A building or buildings within the City and County of San Francisco adequate for uses of a Juvenile Detention Home, with court rooms, meeting rooms, and offices for the accommodation of those connected with the Juvenile Court, Juvenile Detention Home, contained therein, the necessary furnishings and equipment for said building or buildings and all appurtenances for the use and operation of said building or buildings as a Juvenile Detention Home, and the necessary lands for said buildings.

Section 2. The estimated cost of the municipal improvement described

herein was fixed by the Board of Supervisors by Resolution No. 4158 (Series of 1939), passed by more than two-thirds of said board, and approved by the Mayor in the sum of \$1,250,000, and such sum is too great to be paid out of the ordinary annual income and revenue of the city and county in addition to the other annual expenses thereof or other funds derived from taxes levied for that purpose.

The method and manner of payment of the estimated cost of the municipal improvement described herein are by the issuance of bonds of the City and County of San Francisco in the principal amount specified in Section 1 hereof.

Section 3. The special election hereby called and ordered to be held shall be held and conducted and the votes thereat received and canvassed, and the returns thereof made and the result thereof ascertained, determined and declared as herein provided and in all particulars not herein recited said election shall be held according to the laws of the State of California providing for and governing elections in the City and County of San Francisco, and the polls for such election shall be and remain open during the time required by said laws.

Section 4. The said special election hereby called shall be and hereby is consolidated with the General Election to be held Tuesday, November 7, 1944, and the election precincts for said election are hereby fixed and adopted as the election precincts for said special election hereby called, and the voting places and officers of election for said special election shall be those designated and adopted by the Registrar of Voters of said City and County of San Francisco in accordance with law, and reference is hereby made to the official notice of such General Election provided by law.

The ballots to be used at said special election shall be the ballots to be used at said General Election.

Section 5. On the ballots to be used at such special election and on the voting machines used at said special election, in addition to any other matter required by law to be printed thereon, shall appear thereon the following:

"Juvenile Home and Court Bonds, 1944. To incur a bonded indebtedness in the sum of \$1,250,000 for the construction of buildings for uses of a Juvenile Detention Home, with meeting, court rooms and offices and the necessary lands therefor."

To vote for the proposition where ballots are used, and to incur the bonded indebtedness in the principal amount of and for the purposes stated herein, stamp a cross (X) in the blank space to the right of the word "Yes." To vote against the proposition and thereby refuse to authorize the incurring of a bonded indebtedness in the principal amount of and for the purposes stated herein, stamp a cross (X) in the blank space to the right of the word "No."

Where voting machines are used at said special election the said voting machines shall be so arranged that any qualified elector may vote for the proposition by pulling down a lever over the word "Yes" under or near a statement of the proposed proposition appearing on cardboard, paper or other material placed on the front of the machine, and said act shall constitute a vote for the proposition, and by pulling down a lever over the word "No" under or near a statement of the proposed proposition appearing on cardboard, paper or other material placed on the front of the machine, shall constitute a vote against the proposition. Said voting machines and the preparation of the same shall comply in all respects with the provisions of law.

Section 6. If at such special election it shall appear that two-thirds of all the voters voting on said proposition voted in favor of and authorized the incurring of a bonded indebtedness for the purposes set forth in said proposition, then such proposition shall have been accepted by the electors, and bonds

shall be issued to defray the cost of the municipal improvement, other properties and structures described herein. Such bonds shall be of the form and character known as "serials," and shall bear interest at a rate not to exceed 6 per centum per annum, payable semi-annually, and be of the denomination of \$1,000 each. Said bonds shall be designated as "Juvenile Home and Court Bonds, 1944," and shall be numbered from 1 to 1,250, both inclusive, and shall be payable \$450,000 thereof one year from the date of said bonds, beginning with the lowest numbers, and \$400,000 thereof of the next higher numbers in each succeeding year for 2 years until all of said bonds shall be paid.

Section 7. For the purpose of paying the principal and interest on said bonds, the Board of Supervisors shall, at the time of fixing the general tax levy and in the manner for such general tax levy provided levy and collect annually each year until such bonds are paid, or until there be a sum in the Treasury of said City and County set apart for that purpose to meet all sums coming due for the principal and interest on said bonds, a tax sufficient to pay the annual interest on such bonds as the same become due and also such part of the principal thereof as shall become due before the proceeds of a tax levied at the time for making the next general tax levy can be made available for the payment of such principal. Provided further that such tax in any event must be sufficient to raise annually for the first half of the term said bonds have to run, a sufficient sum to pay the interest thereon; and during the balance of the term sufficient to pay such annual interest, and to provide annually a proportion of the principal of said bonds equal to a sum produced by taking the whole amount of said bonds outstanding and dividing it by the number of years said bonds then have to run, and the Board of Supervisors hereby by ordinance provides for the levy of an annual tax sufficient for the purposes aforesaid.

Section 8. Notice of said special election hereby called shall be given as follows: This ordinance shall be published once a day for at least seven (7) days in the San Francisco Chronicle, a newspaper of general circulation published daily in said City and County of San Francisco, being the official newspaper of said City and County and such publication shall constitute notice of said election. In addition, notice of said special election shall be given by publication of notice thereof once a week for at least four (4) weeks in said official newspaper, and the Registrar of Voters is hereby authorized and directed to cause such notice of election to be published.

**Read Second Time and Finally Passed**—Board of Supervisors, San Francisco, August 28, 1944.

Ayes: Supervisors Brown, Gallagher, Gartland, Green, MacPhee, Mancuso, Mead, Meyer, Sullivan, Uhl.

Absent: Supervisor Colman.

I hereby certify that the foregoing ordinance was finally passed by the Board of Supervisors of the City and County of San Francisco.

**DAVID A. BARRY,**  
Clerk.

Approved, San Francisco, August 30, 1944.

**DAN GALLAGHER,**  
Acting Mayor.



## CHARTER AMENDMENT No. 28

**PENSIONS OF RETIRED PERSONS.** Amending section 163 of the charter to provide that penalties on pensioners engaging in gainful occupations shall be suspended for the war and six months thereafter.

Describing and setting forth to the qualified electors of the City and County of San Francisco a proposal to amend the Charter of said City and County by amending Section 163 thereof relating to pensions of retired persons.

The Board of Supervisors of the City and County of San Francisco hereby submits to the qualified electors of the City and County of San Francisco at an election to be held on November 7, 1944, a proposal to amend the Charter of said City and County by amending Section 163, to read as follows:

### PENSIONS OF RETIRED PERSONS

Section 163. (a) No person retired for service or disability and in receipt of a retirement allowance under the retirement system shall serve in any elective or appointive position in the City and County service, including membership on boards and commissions, nor shall such persons receive any payment for service rendered to the City and County after retirement, provided that service as an election officer or juror shall not be affected by this section.

(b) Should any retired person, except persons retired for service prior to January 8, 1932, and persons retired because of disability incurred in the performance of duty, engage in a gainful occupation prior to attaining the age of sixty-two, the retirement board shall reduce that part of his monthly pension or retirement allowance which is provided by contributions of the City and County, to an amount which, when added to the amount earned monthly by him in such occupation, shall not exceed the compensation on the basis of which his pension or retirement allowance was determined.

The provisions of paragraph (b) of this section shall be inoperative during the existing war between the United States and the Axis Powers and for six (6) months after the termination of said war.

Ordered Submitted: Board of Supervisors, San Francisco, August 28, 1944.

Ayes: Supervisors Gallagher, Gartland, Green, MacPhee, Mancuso, Mead, Meyer, Sullivan, Uhl.

Absent: Supervisors Brown and Colman.

I hereby certify that the foregoing Charter amendment was ordered submitted by the Board of Supervisors of the City and County of San Francisco.

DAVID A. BARRY,  
Clerk.

## CHARTER AMENDMENT No. 29

**CONFIDENTIAL SECRETARY FOR SUPERINTENDENT OF SCHOOLS. Amending section 136 of the charter to provide for the appointment of non-civil-service confidential secretary by Superintendent of Schools.**

Describing and setting forth to the qualified electors of the City and County of San Francisco, a proposal to amend the Charter of said City and County by amending Section 136 to provide that the superintendent of schools may appoint a confidential secretary who shall not be subject to the civil service provisions of the Charter.

The Board of Supervisors of the City and County of San Francisco hereby submits to the qualified electors of the City and County of San Francisco at an election to be held on November 7, 1944, a proposal to amend the Charter of said City and County by amending Section 136 thereof so that the same shall read as follows:

### SUPERINTENDENT OF SCHOOLS

Section 136. The superintendent of schools shall be the executive officer of the board of education. He shall be appointed by said board to serve for a term of four years and he shall receive an annual salary of \$10,000 unless an increase in said salary shall be fixed by the board of education and approved by the board of supervisors. The incumbent in the office of superintendent on the 1st day of July, 1942, shall continue to serve at the pleasure of the board.

The superintendent may appoint a confidential secretary who shall not be subject to the Civil Service provisions of this charter and who shall serve at the pleasure of the superintendent.

During his term of office the superintendent may be removed from his office, as in this section hereinafter provided, for misconduct or incompetency after charges setting forth the nature and character of said misconduct or incompetency are filed against the said superintendent. Said charges must be in writing and shall be signed by at least two members of the board of education. A copy of said charges, together with a notice of the time and place of the hearing on the same, shall within five days after the filing of the same be served upon the said superintendent. The mailing of a copy of said charges, with notice of time and place of hearing on the same, by United States registered mail, with the proper amount of postage prepaid thereon, addressed to said superintendent at his last known place of residence, shall be deemed to be a service of said charges as provided for in this section. A public hearing on said charges shall be had by the board of education not less than ten, nor more than twenty, days after the filing of said charges, provided that full power and authority is hereby given to the board of education to continue said hearing from time to time not to exceed sixty days from the commencement thereof, provided that for good cause said board may grant a further continuance on said hearing. The superintendent shall have the right to answer said charges, to appear at the hearing thereof and to be represented by counsel thereat for the purpose of defending himself against said charges. Pending the determination of said charges, the superintendent may be suspended from his office by a majority vote of the board of education, and the board may appoint a qualified person to discharge the duties of said superintendent during the period of suspension. If the board of education after hearing said charges, shall by a two-thirds vote of all the members, deter-



mine that said charges have been sustained, it may by the same vote remove said superintendent from his office. No member of the board shall be entitled to vote on the removal of said superintendent unless he or she has been present at the entire hearing of such charges, provided that any member of the board who has not been present may vote for the removal of the superintendent, if such member has read a transcript of all the testimony taken on said hearing during his absence therefrom, and shall file with the board an affidavit to this effect. If said charges are not sustained by a two-thirds vote of all the members of said board, or if after said charges are sustained, the superintendent is not removed from office as a result thereof, said superintendent shall be reinstated in his position and shall be allowed his salary for the time that he has been under suspension, together with the costs of defending himself against said charges, including a reasonable fee for his attorney to be fixed and allowed by the board. If the charges are sustained, and as a result thereof said superintendent is removed from office, no further salary shall be allowed to said superintendent from the date of his suspension. In the hearing and determination of said charges filed against said superintendent, the judgment of said board of education shall be final unless in determining the sufficiency of said charges said board of education commits a clear abuse of discretion.

The superintendent shall have the powers and duties specified by this charter for department heads, in addition to such powers and duties as are fixed by general law.

The positions of superintendent and deputy superintendent shall be held only by persons of expert or technical training, but shall not be subject to any provisions of this charter prescribing a residence qualification for officers or appointees, provided, however, that during their incumbency appointees to such positions shall reside in the city and county, and in case any appointee shall fail so to do, his appointment shall at once be revoked by the board.

**Ordered Submitted:** Board of Supervisors, San Francisco, July 24, 1944.

Ayes: Supervisors Brown, Gartland, Green, MacPhee, Mancuso, Meyer, Uhl.

Absent: Supervisors Colman, Gallagher, Mead, Sullivan.

I hereby certify that the foregoing Charter amendment was ordered submitted by the Board of Supervisors of the City and County of San Francisco.

DAVID A. BARRY,  
Clerk.

## CHARTER AMENDMENT No. 30

**EMPLOYEES OF STEINHART AQUARIUM. Amending section 52 of the charter to provide that employees of the Steinhart Aquarium with certain exceptions shall be subject to Civil Service.**

Describing and setting forth a proposal to the qualified electors of the City and County of San Francisco to amend the Charter of said City and County by amending Section 52 thereof, relating to the Steinhart Aquarium, so that the employees thereof, with the exception of the director of said aquarium, the secretary of the board in charge thereof, curators and other scientific or professional personnel and part-time positions for which a compensation of less than \$80.00 per month is provided, inclusive of allowances for maintenance and other incidental benefits, shall be subject to, and entitled to the benefits of, the Civil Service provisions of the Charter, and providing that compensations of all employees shall be subject to standardization as provided in Section 151 of the Charter for other city employees.

The Board of Supervisors of the City and County of San Francisco hereby submits to the qualified electors of said City and County, at the general election to be held on November 7, 1944, a proposal to amend the Charter of said City and County by amending Section 52 thereof, so that the same shall read as follows:

### STEINHART AQUARIUM

Section 52. The management, superintendence and operation of the Steinhart Aquarium shall be in charge and under the direction of the California Academy of Sciences of San Francisco. Necessary funds for the maintenance and operation of said aquarium shall be furnished by the City and County to the said California Academy of Sciences of San Francisco, subject to the budget, fiscal and salary ordinance provisions of this Charter. Except the positions of director, secretary of the board of directors, curators and other scientific or professional personnel and part-time positions for which a compensation of less than \$80.00 per month is provided, inclusive of allowance for maintenance and other incidental benefits, all positions in the Steinhart Aquarium shall be subject to the Civil Service provisions of this Charter and upon ratification of this amendment any incumbent of such position in the Steinhart Aquarium, hereby made subject to Civil Service, who shall have held such position continuously for one year prior to such ratification, shall be deemed appointed to such position under the Civil Service provisions of this Charter. Notwithstanding anything to the contrary contained in Section 151 of this Charter, compensation of all employees of said Steinhart Aquarium shall be subject to the Salary Standardization provisions of the Charter.

Nothing herein contained shall abrogate the trust under and by which said Steinhart Aquarium was accepted by the City, or under and by which it is now held.

Ordered Submitted: Board of Supervisors, San Francisco, September 5, 1944.

Ayes: Supervisors Brown, Gallagher, Gartland, Mancuso, Mead, Meyer, Sullivan, Uhl.

Noes: Supervisors Colman, Green.

Absent: Supervisor MacPhee.

I hereby certify that the foregoing Charter amendment was ordered submitted by the Board of Supervisors of the City and County of San Francisco.

DAVID A. BARRY,  
Clerk.

### CHARTER AMENDMENT No. 31

**TERM OF OFFICE OF RECREATION COMMISSION. Amending section 42 of the charter providing term of office of members of Recreation Commission (except ex officio) shall be four years.**

Describing and setting forth a proposal to the electors of the City and County of San Francisco to amend the Charter of said City and County by amending Section 42 thereof, Recreation Commission, by prescribing the terms of office of members of the Recreation Commission.

The Board of Supervisors of the City and County of San Francisco hereby submits to the electors of the City and County of San Francisco at the general

election to be held on November 7, 1944, a proposal to amend the Charter of said City and County by amending Section 42 thereof, so that the same shall read as follows:

## RECREATION DEPARTMENT

Section 42. The recreation department shall be under the management of a recreation commission consisting of seven members, five of whom shall be appointed by the mayor, and shall serve without compensation. Three of the members appointed by the mayor shall be men and two shall be women. The superintendent of schools and the superintendent of parks shall be members of the commission ex officio.

The term of each of the commissioners, except the ex officio members of said commission, shall be four (4) years, provided that the commissioners in office on the effective date of this amendment shall be continued in their respective offices until the respective terms for which they were appointed shall have expired, subject, however, to the right of the mayor to remove any commissioner from office as provided by this Charter. Upon the expiration of the term of each commissioner, the mayor shall appoint his or her successor for a term of four (4) years. The mayor shall have the power to fill any vacancy on the commission, said appointment being for the unexpired term of the commissioner vacating his office.

The recreation commission shall appoint a superintendent, who shall be the chief executive officer of said department, and who shall hold office at the pleasure of the commission.

The commissioners shall have the complete and exclusive control, management and direction of all playgrounds, recreation centers, and all other recreation facilities, now or hereafter placed under charge of the commission, including exclusive right to erect and to superintend the erection of buildings and structures thereon, and to construct new playgrounds and recreation centers, except as in the charter otherwise provided.

**Ordered Submitted:** Board of Supervisors, San Francisco, July 31, 1944.

**Ayes:** Supervisors Brown, Colman, Gartland, Green, MacPhee, Mancuso, Meyer, Uhl.

**Absent:** Supervisors Gallagher, Mead, Sullivan.

I hereby certify that the foregoing charter amendment was ordered submitted by the Board of Supervisors of the City and County of San Francisco.

DAVID A. BARRY,  
Clerk.

## CHARTER AMENDMENT No. 32

### **EMPLOYEES OF CITY ATTORNEY AND PUBLIC DEFENDER.**

**Adding a new section 34.1 to the charter providing that employees of the offices of the City Attorney and the Public Defender (except attorneys) shall be subject to Civil Service.**

Describing and setting forth a proposal to the qualified electors of the City and County of San Francisco to amend the Charter of said City and County by adding a new section thereto to be known as Section 34.1 (Employees in Offices of City Attorney and Public Defender, Except Attorneys, Under Civil Service.)

The Board of Supervisors of the City and County of San Francisco hereby submits to the qualified electors of the City and County of San Francisco at an election to be held therein on November 7, 1944, a proposal to amend the Charter of said City and County by adding Section 34.1 thereto, to read as follows: Employees in offices of City Attorney and Public Defender, except attorneys, under Civil Service.

### **EMPLOYEES IN OFFICES OF CITY ATTORNEY AND PUBLIC DEFENDER, EXCEPT ATTORNEYS, UNDER CIVIL SERVICE**

Section 34.1. Notwithstanding any other provisions of this Charter, occupants of all positions in the offices of City Attorney and the Public Defender, except assistant attorneys in the offices of the City Attorney and the Public Defender, shall be subject to the Civil Service provisions of this Charter, provided that all such occupants who are actually employed, or who may be on military leave of absence from employment, on the effective date of this amendment, and who have been continuously employed for one year immediately preceding such date or such military leave, shall be continued in their respective positions as if appointed thereto after examination and certification from a Civil Service list of eligibles, and thereafter shall be governed and be subject to the Civil Service provisions of this Charter. Upon their return to service, occupants who have been on military leave shall be appointed according to priority of service.

Ordered Submitted: Board of Supervisors, San Francisco, September 5, 1944.

Ayes: Supervisors Brown, Colman, Gallagher, Gartland, Green, Mancuso, Mead, Meyer, Sullivan, Uhl.

Absent: Supervisor MacPhee.

I hereby certify that the foregoing Charter amendment was ordered submitted by the Board of Supervisors of the City and County of San Francisco.

DAVID A. BARRY,  
Clerk.

### **CHARTER AMENDMENT No. 33**

**REINSTATEMENT OF MUNICIPAL EMPLOYEES SERVING IN AMERICAN RED CROSS. Adding a new section 153.1 to the charter providing for reinstatement in municipal service of persons serving in Red Cross**

Describing and setting forth a proposal to the electors of the City and County of San Francisco to amend the Charter of said City and County by adding a new section thereto to be designated as Section 153.1 thereof, to provide for the reinstatement in their respective positions of all officers and employees of the City and County, as well as non-certificated employees of the Unified School District of said City and County who have resigned from, or relinquished their positions under the government of the City and County, or under the Unified School District of said City and County, to enter the service of the American Red Cross as social service worker, field director or assistant field director therein during the existing war, and providing that

after the effective date of this amendment and for the duration of the existing war between the United States of America and the Axis Powers, leaves of absence shall be granted to employees of the City and County, and of the Unified School District of said City and County for service with the American Red Cross, as social service worker, field director or assistant field director therein.

The Board of Supervisors of the City and County of San Francisco hereby submits to the electors of said City and County at the general election to be held on the 7th day of November, 1944, a proposal to amend the Charter of said City and County by adding a new section thereto to be designated as Section 153.1, which shall read as follows:

## REINSTATEMENT OF AND LEAVES OF ABSENCE FOR MEMBERS OF AMERICAN RED CROSS

Section 153.1 (a). Whenever any officer or employee of the City and County of San Francisco, or any non-certificated employee of the Unified School District thereof, after the 8th day of December, 1941, and during the existence of the present war between the United States of America and the Axis Powers, has resigned from or relinquished his or her position under the government of the City and County, or under said Unified School District thereof, and within a period of sixty days thereafter has entered the service of the American Red Cross, as a social service worker, field director or assistant field director therein, said officer or employee after the termination of his or her service with said American Red Cross, and within the time limits prescribed by law for persons on military leave, shall be entitled to resume his or her position from which he or she resigned, or which he or she relinquished, upon presentation of proof that said person did within sixty days after resigning from, or relinquishing, his or her position with the City and County, or with the Unified School District thereof, enter the service of the American Red Cross as a social service worker, field director or assistant field director. Service with the American Red Cross as a social service worker, field director or assistant field director, during the existing war shall be deemed to be service with the City and County insofar as seniority of service and compensation are concerned, and said person so serving with the said American Red Cross shall be deemed to be on military leave, and shall be entitled to all the rights and privileges accorded to other officers and employees of said City and County who have been granted military leave to serve in the Armed Forces of the United States, or of the State of California.

The rights and privileges herein granted to former officers and employees serving as social service workers, field directors or assistant field directors with the American Red Cross shall cease at the expiration of two years after the end of the present war between the United States of America and the Axis Powers, provided, however, that any person who severs his or her connection with the American Red Cross, and who fails to seek reinstatement to his or her position with the City and County, or with the Unified School District, within the time limits prescribed for persons on military leaves as defined in Section 153 of the Charter and rules of the Civil Service Commission, shall not be entitled to reinstatement.

(b) From and after the effective date of this amendment military leave as provided in Section 153 of this Charter for those serving in the Armed Forces of the United States or of the State of California shall be granted for service with the American Red Cross as social service worker, field director or assistant field director.



**Ordered Submitted: Board of Supervisors, San Francisco, August 21, 1944.**

**Ayes:** Supervisors Brown, Colman, Gallagher, Gartland, Green, MacPhee, Mancuso, Mead, Meyer, Sullivan, Uhl.

I hereby certify that the foregoing Charter amendment was ordered submitted by the Board of Supervisors of the City and County of San Francisco.

DAVID A. BARRY,  
Clerk.

## CHARTER AMENDMENT No. 34

**POLICE DEPARTMENT. Adding Charter Section 168.1, prescribing retirement provisions for present and future members of Police Department.**

Describing and setting forth a proposal to the qualified electors of the City and County of San Francisco, State of California, to amend the Charter of said City and County by adding Section 168.1 thereto, relating to present and future members of the Police Department.

The Board of Supervisors of the City and County of San Francisco hereby submits to the qualified electors of said City and County, at the general election to be held on the 7th day of November, 1944, a proposal to amend the Charter of said City and County, by adding thereto a new section to be designated Section 168.1, as follows:

### DEFINING RETIREMENT PROVISIONS—POLICE DEPARTMENT

Section 168.1. Members of the Police Department, as defined in this section, who are members of the Retirement System under Sections 165, 166 or 168 of the Charter on the effective date hereof, hereby designated as the first day of July, 1945, and persons who become members of said department after said effective date, shall be members of the Retirement System on and after said date, subject to the following provisions of this Section 168.1, in addition to the provisions contained in Sections 158 to 161, both inclusive, of this Charter notwithstanding the provisions of any other section of the Charter. Members of the said department who are members of the Retirement System under Section 166 of the Charter on said effective date, however, shall have the option to be exercised in writing on a form furnished by the Retirement System and to be filed at the office of said System not later than ninety days after the effective date hereof, of being members of the System under Section 166 instead of Section 168.1, the election under said option to be effective on said effective date. In like manner, members of the said department who are members of the Retirement System under Sections 165 or 168 of the Charter shall have the option, to be exercised in writing on a form furnished by the Retirement System, and to be filed at the office of said System not later than ninety days after the effective date hereof, of being members of the System under Sections 165 or 168, respectively, instead of Section 168.1, the election to be effective on said effective date, provided, that members who are absent by reason of service in the armed forces of the United States or by reason of any other service included in Section 161 of the Charter, on the effective date of the amendment shall have the same option of electing to be members under Section 165, 166 or 168, as the case may be, instead of Section 168.1, until ninety days after their return to service in the Police



Department. On and after said date, the persons who affirmatively exercise said option, shall continue to be members of the System under Sections 166, 165 or 168, respectively, and shall not be subject to any of the provisions of Section 168.1.

(A) The following words and phrases as used in this section, unless a different meaning is plainly required by the context, shall have the following meaning:

"Retirement allowance," "death allowance" or "allowance," shall mean equal monthly payments, beginning to accrue upon the date of retirement, or upon the day following the date of death, and continuing for life unless a different term of payment is definitely provided by the context.

"Compensation," as distinguished from benefits under the Workmen's Compensation Insurance and Safety Act of the State of California, shall mean the remuneration payable in cash, by the City and County, without deduction except for absence from duty, for time during which the individual receiving such remuneration is a member of the Police Department.

"Compensation earnable" shall mean the compensation which would have been earned had the member received compensation without interruption throughout the period under consideration and at the rates of remuneration attached at that time to the ranks or positions held by him during such period, it being assumed that during any absence he was in the rank or position held by him at the beginning of the absence, and that prior to becoming a member of the Police Department he was in the rank or position first held by him in such department.

"Benefit" shall include "allowance," "retirement allowance," "death allowance" and "death benefit."

"Final compensation" shall mean the average monthly compensation earnable by a member during the three years immediately preceding his retirement, or death before retirement.

For the purpose of the Retirement System and of this section, the terms "member of the Police Department," "member of the department" or "member," shall mean any officer or employee of the Police Department whose employment therein began prior to January 1, 1900, or whose employment therein began or shall begin after that date, and was or shall be subject to the Charter provisions governing entrance requirements for members of the uniformed force of said department, and said terms further shall mean, for the effective date of their employment in said department, persons employed on the effective date hereof, regardless of age, or employed after said date at an age not greater than thirty-five years in the Police Department to perform the duties now performed under the titles of Criminologist, Photographer, Police Patrol Driver, Police Motor Boat Operator, Woman Protective Officer, Police Woman or Jail Matron. Any police service performed by such a member of the Police Department outside the limits of the City and County and under orders of a superior officer of any such member, shall be considered as City and County service, and any disability or death incurred therein shall be covered under the provisions of the Retirement System.

"Retirement System" or "System" shall mean San Francisco City and County Employees' Retirement System as created in Section 158 of the Charter.

"Retirement Board" shall mean "Retirement Board" as created in Section 159 of the Charter.

"Charter" shall mean the Charter of the City and County of San Francisco.

Words used in the masculine gender shall include the feminine and neuter genders, and singular numbers shall include the plural, and the plural the singular.

**"Interest" shall mean interest at the rate adopted by the Retirement Board.**

(B) Any member of the Police Department who completes at least thirty years of service in the aggregate, regardless of age, or at least twenty-five years of service in the aggregate, and attains the age of 55 years, said service to be computed under Subsection (H) hereof, may retire for service at his option. Members shall be retired on the first day of the month next following the attainment by them of the age of seventy years during the twelve months ending June 30, 1946; the age of sixty-nine years during the twelve months ending June 30, 1947; the age of sixty-eight years during the twelve months ending June 30, 1948; the age of sixty-seven years during the twelve months ending June 30, 1949; the age of sixty-six years during the twelve months ending June 30, 1950, and thereafter, following the attainment of the age of sixty-five years. A member retired after meeting the service and age requirements in the two sentences next preceding, shall receive a retirement allowance equal to fifty per cent of the final compensation of said member, as defined in Subsection (A) hereof, plus an allowance at the rate of  $1\frac{2}{3}$  per cent of said final compensation, for each year of service rendered prior to attaining age 60 and after qualifying as to age and service for retirement. Any member may retire, regardless of age, after rendering twenty-five years of service in the aggregate, computed under Subsection (H), but in such event, his retirement allowance shall be such as can be provided at the age of retirement by the actuarial value, at the age of retirement, of the retirement allowance to which he would be entitled at the date upon which he would qualify for retirement under the first two sentences of this paragraph, deferred to that date. Before the first payment of a retirement allowance is made, a member retired under this subsection or Subsection (C), may elect to receive the actuarial equivalent of his allowance, partly in an allowance to be received by him throughout his life, and partly in other benefits payable after his death to another person or persons, provided that such election shall be subject to all the conditions prescribed by the Board of Supervisors to govern similar elections by other members of the Retirement System, including the character and amount of such other benefits.

(C) Any member of the Police Department, who becomes incapacitated for performance of his duty by reason of any bodily injury received in, or illness caused by the performance of his duty, shall be retired, and shall receive a retirement allowance equal to fifty per cent of the final compensation of said member, as defined in Subsection (A) hereof, provided that if at that time, he is qualified as to age and service for retirement under Subsection (B), he shall receive an allowance equal to the retirement allowance which he would receive if retired under Subsection (B) but not less than fifty per cent of said final compensation. Any member of the Police Department who becomes incapacitated for performance of his duty, by reason of a cause not included under the provisions of the immediately preceding sentence, and who shall have completed at least ten years of service in the aggregate, computed as provided in Subsection (H) hereof, shall be retired upon an allowance of one and one-half per cent of the final compensation of said member, as defined in Subsection (A) hereof for each year of service, provided that said allowance shall not be less than twenty-five per cent of said final compensation. The question of retiring a member under this subsection may be brought before the Retirement Board on said Board's own motion, by recommendation of the Police Commission, or by said member or his guardian. If his disability shall cease, his retirement allowance shall cease, and he shall be restored to the service in the rank he occupied at the time of his retirement.

(D) If a member of the Police Department shall die before or after retirement as a result of an injury received in, or illness caused by the performance

of his duty, a death allowance shall be paid, beginning on the date next following the date of death, to his surviving wife, equal to fifty per cent of the final compensation of said member as defined in Subsection (A) hereof, throughout her life or until her remarriage, provided that if the member, at the time of death, was qualified as to age and service for retirement under Subsection (B), the death allowance payable under this Subsection (D), shall be equal to the retirement allowance which the member would have received if he had been retired under Subsection (B) on the day of death but not less than fifty per cent of said final compensation, and if he be retired prior to death, the death allowance payable shall be equal to the retirement allowance of the member. If there be no surviving wife entitled to an allowance hereunder, or if she die or remarry before every child of such deceased member attains the age of eighteen years, then said allowance shall be paid to his child or children under said age, collectively, to continue until every such child dies or attains said age, provided that no child shall receive any allowance after marrying or attaining the age of eighteen years. Should said member leave no surviving wife and no children under the age of eighteen years, but leave a parent or parents dependent upon him for support, the parents so dependent shall collectively receive said monthly allowance during such dependency. No allowance, however, shall be paid under this subsection to a surviving wife following the death of a member unless she was married to the member prior to the date of the injury or onset of the illness, which results in death.

(E) That portion of any allowance payable because of the death or retirement of any member of said department which is provided by contributions of the City and County, shall be reduced in the manner fixed by the Board of Supervisors, by the amount of any benefits, other than medical benefits, payable to or on account of such person, under the Workmen's Compensation Insurance and Safety Law of the State of California and because of the injury or illness resulting in said death or retirement.

(F) If a member of the Police Department shall die, before retirement, from causes other than an injury received in, or illness caused by the performance of duty, or regardless of cause, if no allowance shall be payable under Subsection (D) preceding, a death benefit shall be paid to his estate or designated beneficiary, the amount of which and the conditions for the payment of which shall be determined in the manner prescribed by the Board of Supervisors for the death benefit of other members of the Retirement System. Upon the death of a member after retirement and regardless of the cause of death, the sum of five hundred dollars shall be paid to his estate or designated beneficiary in the manner and subject to the conditions prescribed by the Board of Supervisors for the payment of a similar benefit upon the death of other retired members.

(G) Should any member of the department cease to be employed as such a member, through any cause other than death or retirement or transfer to another office or department, all of his contributions, with interest credited thereon, shall be refunded to him subject to the conditions prescribed by the Board of Supervisors to govern similar terminations of employment of other members of the Retirement System. If he shall again become a member of the department, he shall redeposit in the Retirement Fund, the amount refunded to him. Contributions, with interest, which are credited because of service rendered in any other office or department and which will not be counted under Subsection (H), to any person who becomes a member of the Retirement System under this section, shall be refunded to him forthwith. Should a member of the Police Department become an employee of any other office or department, a portion of his contributions with credited interest equal to the contributions which would have accumulated to his credit if he had

been employed in said other office or department at the rate of compensation received by him in the Police Department, shall remain credited to his account, and he shall receive credit for service to the extent of said accumulated contributions, and the balance of his contributions with credited interest shall be refunded to him forthwith.

(H) The following time shall be included in the computation of the service to be credited to a member of the department for the purpose of determining whether such member qualifies for retirement:

(1) Time during and for which said member is entitled to receive compensation because of services as a member of the Fire or Police Department;

(2) Time during which said member served and received compensation as a jail matron in the office of the Sheriff;

(3) Solely for the purpose of determining qualification for retirement under Subsection (C) for disability not resulting from injury received in, or illness caused by performance of duty, time during which said member served and received compensation in any other status requisite for membership in the Retirement System;

(4) Time during which said member, while absent from a status included in paragraphs (1), (2) or (3) next preceding, by reason of service in the armed forces of the United States of America, or by reason of any other service included in Section 161 of the Charter, during any war in which the United States was or shall be engaged or during other national emergency.

(I) All payments provided under this section shall be made from funds derived from the following sources, plus interest earned on said funds:

(1) The rate of contribution of each member under this section shall be based on his age taken to the next lower complete quarter year, at the date he became a member under Section 165 or 168, as a member of the Police Department, as defined in this section, in the case of persons who are members under these sections, or at the effective date of this amendment, in the case of persons who are members under Section 166, and his age taken to the next lower completed year, when he entered the Police Department, or on his age at the date he becomes a member under this section, in the case of persons who become members on or after the effective date of this amendment. The age of entrance into the Police Department shall be determined by deducting the member's service as a member of the Fire and Police Departments and as a jail matron in the office of the Sheriff, prior to the date upon which his age is based for determination of his rate of contribution according to the sentence next preceding. The normal rate of contribution of each such member, to be effective from the effective date of membership under this section, shall be such as, on the average for such member, will provide, assuming service without interruption, under Subsection (B) of this section, one-third of that portion of the service retirement allowance to which he would be entitled, upon first qualifying as to age and service, for retirement under that subsection, which is based on service rendered after the date upon which his age is based for determination of his rate of contribution according to the first sentence in this paragraph, and assuming the contribution to be made from that date.

(2) There shall be deducted from each salary payment made to a member under this section, a sum determined by applying the member's rate of contribution to such salary payment. The sum so deducted shall be paid forthwith to the Retirement System. Said contribution shall be credited to the individual account of the member from whose salary it was deducted, and the total of said contributions, together with interest credited thereon in the same manner as is prescribed by the Board of Supervisors for crediting interest to contributions of other members of the Retirement System, shall be applied to provide part of the retirement allowance granted to, or allow-

ance granted on account of said member, under this section or shall be paid to said member or his estate or beneficiary as provided in Subsections (F) and (G) of this section.

(3) Contributions based on time included in paragraphs (1), (2) and (4) of Subsection (H), and deducted prior to the effective date hereof, from compensation of persons who become members under this section, and standing with interest thereon, to the credit of such members on the records of the Retirement System on said date, shall continue to be credited to the individual accounts of said members and shall be combined with and administered in the same manner as the contributions deducted after said date.

(4) The total contributions, with interest thereon, made by or charged against the City and County and standing to its credit, in the accounts of the Retirement System, on account of persons who become members under this section, shall be applied to provide the benefits under this section.

(5) The City and County shall contribute to the Retirement System such amounts as may be necessary, when added to the contributions referred to in the preceding paragraphs of this Subsection (I), to provide the benefits payable under this section. Such contributions of the City and County to provide the portion of the benefits hereunder which shall be based on service rendered by each member prior to the date upon which his age is based for determination of his rate of contribution in paragraph (1), Subsection (I), shall not be less during any fiscal year than the amount of such benefits paid during said year. Such contributions of the City and County to provide the portion of the benefits hereunder which shall be based on service rendered by respective members on and after the date stated in the next preceding sentence, shall be made in annual installments, and the installment to be paid in any year shall be determined by the application of a percentage to the total salaries paid during said year, to persons who are members under this section, said percentage to be the ratio of the value at the effective date hereof, or at the later date of a periodical actuarial valuation and investigation into the experience under the System as provided by the Board of Supervisors, of salaries thereafter payable to said members then in the Police Department to the value at said effective or said later date, of the benefits thereafter to be paid under this section, from contributions of the City and County, less the amount of such contribution, and plus accumulated interest thereon, then held by said System to provide said benefits on account of service rendered by respective member after the date stated in the sentence next preceding. Said values shall be determined by the Actuary, who shall take into account the interest which shall be earned on said contributions, the compensation experience of members, and the probabilities of separation by all causes, of members from service before retirement and of death after retirement. Said percentage shall be changed only on the basis of said periodical actuarial valuation and investigation into the experience under the System.

(6) To promote the stability of the Retirement System through a joint participation in the results of variations in the experience under mortality, investment and other contingencies, the contributions of both members and the City held by the System to provide the benefits under this section, shall be a part of the fund in which all other assets of said System are included, but the accounts of said System shall be kept in such manner as to permit the segregation of assets equal to the total contributions with interest credited thereon, held by said System to provide the benefits under this section, and to permit the determination that, except for said joint participation, all payments provided under this section shall be made from the contributions provided for herein. Nothing in this section shall affect the obligations of



the City and County to pay to the Retirement System any amounts which may or shall become due under the provisions of the Charter prior to the effective date hereof, and which are represented on said effective date, in the accounts of said System by debits against the City and County.

(J) Upon the completion of the years of service set forth in Subsection (B) of this section as requisite to retirement, a member shall be entitled to retire at any time thereafter in accordance with the provisions of said Subsection (B), and nothing shall deprive said member of said right.

(K) No person retired under this section, for service or disability and entitled to receive a retirement allowance under the Retirement System shall serve in any elective or appointive position in the City and County service, including membership on boards and commissions, nor shall such person receive any payment for service rendered to the City and County after retirement, provided that service as an election officer or juror shall not be affected by this section.

Should any such retired person, except persons retired because of disability incurred in the performance of duty, engage in a gainful occupation prior to attaining the age of sixty-two, the Retirement Board shall reduce that part of his monthly pension or retirement allowance which is provided by contributions of the City and County, to an amount which, when added to the amount earned monthly by him in such occupation, shall not exceed his compensation at the time of his retirement.

(L) Any section or part of any section in this Charter, insofar as it should conflict with this Section 168.1, or with any part thereof, shall be superseded by the contents of said Section 168.1. In the event that any word, phrase, clause or subsection of this section shall be adjudged unconstitutional, the remainder thereof shall remain in full force and effect.

This amendment shall take effect on the first day of July, 1945.

Ordered Submitted: Board of Supervisors, San Francisco, September 5, 1944.

Ayes: Supervisors Brown, Colman, Gallagher, Gartland, Green, MacPhee, Mancuso, Mead, Meyer, Sullivan, Uhl.

I hereby certify that the foregoing Charter amendment was ordered submitted by the Board of Supervisors of the City and County of San Francisco.

DAVID A. BARRY,  
Clerk.





# **Vote YES on Number 27**

---

## **Do Juvenile Delinquents Deserve CARE? - or CARELESSNESS?**

---

**Number 27 will provide \$1,250,000 in five-year bonds  
for the site and buildings of a modern  
"Care Center" for delinquents**

---

### **WHAT YOUR OFFICIALS SAY . . .**

**Mayor Lapham . . .** The present Juvenile Home was never built as it should have been. It is a sad imitation of what really is needed if we are to try to rehabilitate wayward youth.

**Judge Meikle . . .** As judge of the Juvenile Court, I have seen the difficulties experienced by our probation staff in trying to assist delinquent children. The problems are too much for the equipment available to the staff—and are unfair to the children.

**Chief Probation Officer Ososke . . .** Never before has the need been so great, and never before has the city been so conscious of youth welfare. A new juvenile home is a responsibility of the community.

**Juvenile Probation Committee . . .** It is not a question of coddling youngsters who have misbehaved. It is a question of giving them a fair chance to return to normal living by providing surroundings where these cases can be treated instead of incarcerated.

---

**NOTE:** Since the law requires a two-thirds majority on this bond issue, it is imperative that you Vote YES on Proposition Number 27.



# WHY SAN FRANCISCO MUST HAVE A NEW DETENTION HOME FOR YOUTH REHABILITATION

---

- 1** The present facilities for handling juvenile delinquency cases—facilities nearly 30 years old—are inadequate, ANTIQUATED and do not provide the proper environments for youth rehabilitation.
- 2** Insufficient facilities, crowded rooms, lack of provision for educational work, vocational training and recreational areas have a DEPLORABLE effect upon the attempt to attain the objective for which the Juvenile Court was created.
- 3** It is impossible for this community to provide modern methods of solving its youth problems with facilities which were out-of-date years ago.
- 4** The seriousness of the present situation is undeniable. When the present Detention Home at 150 Otis Street was built in 1915, San Francisco had a population of 416,912, while in 1944 it is estimated the population has increased to about 800,000.
- 5** The present facilities often prevent the proper segregation of youth as to sex and as to the nature of the offenses, or misfortunes, for which they may be detained. There is only one small play-yard, for example, and so situated between buildings as to receive very little sunlight.
- 6** It is impossible to meet the demands of a present-day school population of 139,703 with facilities designed on a basis of caring for a school population of only 61,941.

## COST

Proposition Number 27 calls for a bond issue of \$1,250,000. This sum will provide for the acquisition of a new and better site on which to construct modern buildings for the Juvenile Court, the Probation Department and Detention Home. Included in the new plans is provision for recreational areas permitting the segregation of youth as to sexes and offenses. This sum also provides for the most modern equipment in all departments and for up-to-date educational work and vocational training, so vital to youth rehabilitation.

## GAIN

Not only will San Francisco advance its reputation as the city that knows how, but it will be assured of social gains, the value of which is beyond calculation. Those who devote their lives to improving social conditions among youth will be provided with adequate means with which to achieve success of a proportion guaranteeing a reduction in juvenile delinquency.

---

YOU CAN'T GO WRONG WHEN YOU TREAT OUR YOUTH RIGHT!  
**VOTE YES ON BOND PROPOSITION NUMBER 27**

At the General Election on November 7, 1944

This pamphlet ordered submitted by the Board of Supervisors.

# VOTE YES ON NUMBER 27

---

## Endorsed By —

San Francisco Chamber of Commerce  
San Francisco Women's Chamber of Commerce  
San Francisco Second District California Congress of Parents and Teachers  
Junior League of San Francisco  
State Women's Club of San Francisco  
And Many Other Civic and Fraternal Organizations

## Sponsored By —

The Mayor's Committee on the New Juvenile Home:

Hon. Theresa Meikle  
*Honorary Chairman*  
Mr. Philip F. Landis  
*Chairman*  
Mrs. Paul Eliel  
*Vice Chairman*  
Mrs. A. O. Field  
*Vice Chairman*  
Mr. Harold Wagner  
*Vice Chairman*  
Mrs. H. W. Thomas  
*Secretary*  
Arnstein, Hugo  
Bertola, Dr. Mariana  
Bloch, Mrs. Fred W.  
Bonapart, Benjamin  
Burns, Rev. Jackson  
Carpenter, Russell G.  
Carr, Mrs. Gladys E.  
Cleary, Mrs. E. V.  
Conner, L. C.  
Cooley, Merriel E.  
DeMartini, J. G.  
Dippel, Mrs. Henry S., Jr.  
Driscoll, John  
Falk, Adrien  
Hale, Mrs. Prentis Cobb  
Hance, Miss Eva

Hatch, Ray C.  
Johnson, Elmer  
Koshland, Daniel  
Leffler, Rev. John  
Macey, Mrs. James  
Mailliard, J. W., Jr.  
Marisch, Frank  
Matteucci, Miss Rita  
McGinn, Mrs. Hulda  
Moore, Mrs. Joseph A., Jr.  
Musante, Mrs. A. S.  
Neubauer, John C.  
Noble, Weller  
O'Connell, John  
Ososke, George W.  
Pence, Miss Edith  
Rogers, Mrs. William L.  
Ryan, Mrs. Emily E.  
Roth, Mrs. William P.  
Shea, Rev. Eugene J.  
Shelley, Senator John F.  
Smith, Robert L.  
Tilden, John L.  
Tucker, Mrs. Nion  
Williamson, Ray  
Wilson, George  
Wooten, Wesley M.  
Zachrisson, Carl U.

Now the welfare of San Francisco Youth is in YOUR hands!

---

# VOTE YES ON BOND PROPOSITION NUMBER 27

Tuesday, November 7, 1944

# VOTE

# YES PROPOSITION 34

## CHARTER AMENDMENT

**PROPOSITION 34 provides adjustment of existing retirement provisions for present and future members of the police department, with its prime purpose a younger police force in the post war years.**

- SAN FRANCISCO POLICEMEN ARE THE OLDEST (ON THE AVERAGE) OF ALL METROPOLITAN POLICE DEPARTMENTS. Why? Because they are not forced to retire until aged 70 and because they cannot retire until after 37½ years' police service.
- Experts agree that CRIMES OF VIOLENCE (ALREADY UP) WILL SKYROCKET AFTER THE WAR! YOUR POLICE FORCE NEEDS YOUNGER MEN. It is a dangerous job!
- A study made in 1939 of 292 cities of the United States by the Citizens' Budget Commission of New York revealed that San Francisco's police retirement provisions are the most backward of all such cities. THERE HAS BEEN NO CONSTRUCTIVE CHANGE IN MORE THAN THIRTY YEARS.
- PROPOSITION 34 will require policemen to retire at age 65 and permit them to retire after 30 years' service (or at age 55 with a minimum of 25 years' service). A schedule of provisions of other cities is shown on the reverse side. Please examine it carefully.
- PROPOSITION 34 WILL REQUIRE POLICEMEN TO INCREASE THEIR PAYMENTS INTO THE FUND TO SUMS AVERAGING 6% OF THEIR WAGES. They are willing to make these payments for this SOUND, HUMANE PLAN.
- PROPOSITION 34 is the result of many months' study and research by representatives of large and small tax-payer groups and department representatives. It is widely endorsed by business, civic, and labor groups because it is FAIR and EQUITABLE.

### ENDORSED BY:

Board of Supervisors  
Police Commission  
S. F. Labor Council, A.F.L.  
San Francisco C.I.O. Council  
S. F. Bldg. & Construction  
Trades Council  
Civic League of Improvement Clubs  
S. F. County Council, American  
Legion

Apartment House Association of S. F.  
Building Owners & Managers Assn.  
Calif. Northern Hotel Association  
S. F. Real Estate Board  
Down Town Association  
S. F. Chamber of Commerce  
S. F. Junior Chamber of Commerce  
Women's Chamber of Commerce  
Market Street Association

and a host of other organizations.

The following table shows how unfair and inadequate are our existing police retirement provisions and how #34 will remedy a long-standing deficiency:

**POLICE SERVICE REQUIRED FOR RETIREMENT ALLOWANCE  
POLICE DEPARTMENTS OF REPRESENTATIVE CITIES**

	Police Service Required For Optional Retirement	Average Sums Paid By Policemen
	25 years, or	2% (old members); actu- arial rate based on age (new members)—similar to proposed #34
New York .....	20 years at age 55	
Chicago .....	20 years at age 50	3½%
Detroit .....	25 years	5%
Los Angeles .....	25 years	4%
Boston .....	25 years at age 60	4%
New Orleans .....	20 years	3 to 5%
Seattle .....	25 years	2%
San Diego .....	25 years	4%
Oakland .....	25 years at age 55	5%
SAN FRANCISCO (now) .....	37½ years	4½%

**#34 WILL CORRECT THIS DEFICIENCY BY PROVIDING**

SAN FRANCISCO (Proposed).....	30 years, or age 55 with at least 25 years service	6%
----------------------------------	--	----

\* \* \* \*



Under Proposition #34, compulsory retirement age will be reduced from 70 to 65.



**MODERNIZE YOUR  
POLICE DEPARTMENT!**



**PROVIDE EMPLOYMENT  
FOR YOUNGER MEN  
AFTER THE WAR!**



**PROTECT RETIREMENT  
RIGHTS OF PRESENT AND  
FUTURE MEMBERS OF  
POLICE DEPARTMENT  
IN ARMED FORCES!**



**VOTE "YES" # 34**

**PLEASE  
SEE OTHER SIDE**



# Vote YES on No. 26

## (SEWER BONDS)

The people of San Francisco have an opportunity by voting "YES" on Proposition No. 26 to help their city take a long step toward solution of its sewer problem and to provide jobs in the post-war period.

Passage of the \$12,000,000 sewer bond issue will take essential projects for the betterment of San Francisco out of the mere planning stage and place them in line for actual accomplishment.

Sewer construction and reconstruction and further development of sewage disposal works are of foremost importance in the city's master plan for civic improvement. In voting for Proposition No. 26 the people will start translation of this plan into action.

During depression and war years the city's sewer and sewage disposal problem has been under constant study. A construction program to provide adequate sewers for all sections of the city and to build additional disposal facilities to clear our bay and ocean coast line of pollution has been formulated. In all it will cost not less than \$25,000,000. This bond issue is a part of the plan to meet the entire need. Together with tax funds on hand it will accomplish at least the most urgent half of the overall program.

Adequate sewers and sewage disposal works are as essential to a city as plumbing is to a home. Failure to provide funds for sewers is being penny wise and pound foolish.

## NEW SEWERS AN ECONOMY

Some San Francisco sewers have been outgrown and now are too small for the heavy run-off of winter storm waters; consequently sewage and storm waters back up into basements of homes and businesses. Some of the city's mains have settled and are worn out after sixty years of service; costs of sewer maintenance and repairs have risen to a point (more than \$350,000 a year) where construction of new sewers to replace those worn out will be an economy. New areas of the city are being developed or are ready for development; these areas must have sewers and such sewers will pay for themselves in increased taxes from the newly improved districts.

THE NEEDS ABOVE OUTLINED WILL BE PROVIDED FOR BY THIS BOND ISSUE—NEEDS THAT CANNOT SAFELY AND SHOULD NOT BE POSTPONED.

Provision of adequate sewers in every neighborhood of the city has been placed ahead of sanitary sewage disposal, but the latter is not overlooked. Complete sanitary disposal is included in the overall sewer plan. In the immediate program are funds to enlarge the Sunset-Richmond treatment plant and to make detailed plans and purchase land for a North Beach treatment plant to remove Bay pollution.

Matching funds for sewage disposal works may be made available by the state. In such case San Francisco *after passage of this bond issue* will be in a position to eliminate all sewage pollution of its bay and ocean waters.

The map on page 3 of this folder shows the post-war construction projects that will be financed by this bond issue and tax funds on hand. Each project, even though small, will improve conditions in an entire drainage area. Such areas are shaded on the map.



# CITIZENS' COMMITTEE URGES BONDS

Much more work than shown on the map can be done in the post-war period if federal matching funds are made available to encourage the creation of jobs. San Francisco will not be in a position to take advantage of federal aid unless these bonds are voted.

A citizens' Master Plan Committee after over a year of study of San Francisco's post-war problems decided that for public health and the city's growth SEWERS COME FIRST. The committee urged this bond issue.

Mayor Lapham and the Board of Supervisors approved the committee's recommendation and submitted it to the voters.

To provide adequate sewers for every district of San Francisco, to encourage early development of vacant areas within the city, to make possible the elimination of pollution from our beaches, to be ready to cooperate with the federal government in creating post-war jobs, to go forward with San Francisco's master plan, to make your city a better and more healthful place to live,

## Vote YES on No. 26

### Citizens' Committee for Sewer Bonds

JERD F. SULLIVAN, *Chairman*

MRS. CHARLES B. PORTER, *Vice-Chairman*

PARKER MADDUX, *Chairman, Finance Committee*

Allen, Harry B.  
Baen, C. E.  
Baker, Wakefield  
Baron, Edw. B.  
Bertola, Dr. Mariana  
Beswick, Mrs. Daniel K.  
Blyth, Chas. R.  
Block, Bishop Karl Morgan  
Boudoures, Peter  
Bourgeault, Nadeau L.  
Brooks, T. A.  
Brown, Edmund G.  
Browne, Edward R.  
Budde, Henry  
Chow, Albert K.  
Clark, Hervey Parke  
Cline, Dr. John W.  
Coldwell, Colbert  
Coleman, S. Waldo  
Colman, Mrs. Jesse C.  
Dailey, Gardner  
deBonis, George  
del Carlo, Dan  
Derre, Mrs. Louis  
Dill, Marshall  
Easton, Erwin  
Eloesser, Dr. Leo  
Erskine, Morse  
Evans, Dr. George H.  
Falk, Adrien J.  
Fay, Philip J.  
Fazackerley, Don  
Fennimore, Arthur R.  
Fisher, Vining T.  
Fitzgerald, Mrs. Minette  
Fountain, Cecil A.

Frank, Mrs. Ludwig  
Galliano, Chas. S.  
Gay, George  
Geiger, Dr. J. C.  
Gerbode, Mrs. Frank  
Griffith, Miss Alice  
Gunst, Morgan A.  
Haas, Walter  
Hale, Marshal  
Halley, James Leo  
Hanley, Herbert  
Hanvey, Howard G.  
Henno, Mrs. Jean  
Howell, J. W.  
Hutchison, E. Elmore  
Johns, George W., Jr.  
Johnson, Elmer G.  
Keesling, Francis V.  
Keil, Edward D.  
Kleiser, George W.  
Koshland, Daniel E.  
Koster, Frederick J.  
Langhorst, Fred  
Larke, Thomas, Jr.  
Liebes, Dorothy Wright  
Lindgren, Chas. J.  
London, Dan E.  
Magee, Wm. A.  
Magnin, Grover  
Mailliard, J. W., Jr.  
Malatesta, Stephen  
Mattyas, Jennie  
McEnerney, Garrett, II  
Mentzer, Dr. Stanley H.  
Merchant, Wm. G.  
Miller, C. O. G.

Minudri, Molly  
Moffitt, James K.  
Morley, Grace L.  
Murphy, Daniel C.  
Newburgh, Carroll  
Parr, Fred  
Paschell, Phil  
Perego, Mrs. Grace  
Post, Langdon  
Rae, James  
Reynolds, Dr. Ralph  
Sahlein, Mrs. Henry  
Sandy, George H.  
Shelley, John F.  
Smith, John H.  
Smith, Russell  
Spencer, Eldridge T.  
Steinhart, Jesse H.  
Stern, Mrs. Sigmund  
Sullivan, James J.  
Thompson, Joseph  
Tilton, L. Deming  
Timlow, Miss Emily  
Turkington, E. L.  
Tynan, Jos. J., Jr.  
Walkup, Ward G.  
Watchman, Alexander  
Weill, Michel  
Wente, Carl  
Werth, Margaret  
White, Theodore  
Williams, Alfred C.  
Wilson, George  
Wilson, Lloyd E.  
Wurster, Catherine Bauer

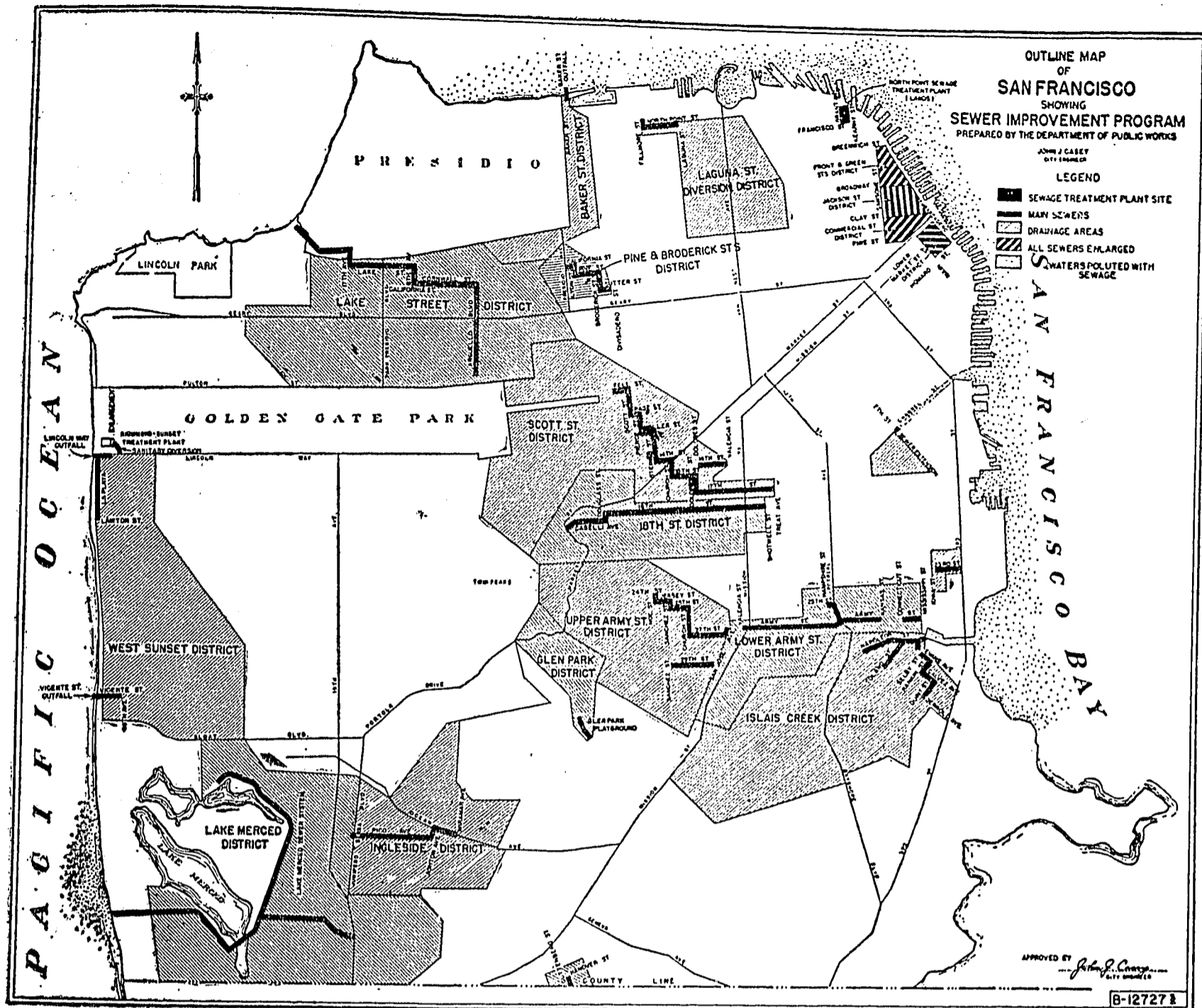

## MEDICAL PROFESSION URGES YES on No. 26

**DR. J. C. GEIGER, Director of Public Health, San Francisco:**

Next in importance to the public water supply is the maintenance of sanitary conditions in any city through adequate sewerage facilities.

The proposed Bond Issue will carry on San Francisco's essential program in this regard. Without these funds sanitation will suffer and the best interests of the city will not be conserved.

I do not believe San Francisco will longer tolerate such conditions as exist.

**DR. STANLEY H. MENTZER, President, San Francisco County Medical Society:**

There is no problem in greater need of solution for the welfare of the people than the repair of our dangerously antiquated sewerage system. I hope the people, for their own protection, will vote in favor of the Sewer Bonds.

**DR. W. T. HARRISON, Medical Director, District 5, U. S. Public Health Service:**

The health of the people as a whole will certainly be benefited by the sewer bond program.

**DR. WALTER H. BROWN, Chairman, Health Council, S. F. Community Chest:**

I consider the proposed bond issue to be one of the most important issues on the November ballot.

**DR. FRANCIS SCOTT SMYTH, *Dean, Medical College, University of California:***

I wish to add my hearty endorsement of the sewage bond issue on the November ballot. It would seem long overdue.

**ABEL WOLMAN, *Dr. Eng., Chairman of Executive Board, American Public Health Association:***

Simple and acceptable municipal housekeeping demands adequate collection of sewage and its prompt treatment. I hope San Francisco undertakes the sewer program that this bond issue will make possible.

**DR. LOWELL S. GOIN, *President, California Medical Association:***

There has been a long-standing need for improved disposal of San Francisco's sewage. We hope that steps will be taken to meet this need in the near future.

**DR. L. R. THOMPSON, *Acting Surgeon General, U. S. Public Health Service:***

The provision and maintenance of facilities for the collection and adequate disposal of sewage wastes are fundamental public health requirements of our urban developments.

---

## **SEWER BONDS ENDORSED BY CIVIC GROUPS**

The following organizations have endorsed Proposition No. 26:

Apartment House Owners & Managers  
Association, Inc.

San Francisco Building and Construction  
Trades Council

San Francisco County Medical Society  
Building Owners & Managers Association

San Francisco Labor Council

Civic League of Improvement Clubs &  
Associations

San Francisco Chamber of Commerce

Warehousemen's Association,  
Port of San Francisco

Municipal Conference

Columbus Civic Club

Down Town Association

Polk-Van Ness-Larkin District Merchants  
Association

California Northern Hotel Association

San Francisco Society of Architects

Telegraph Hill Neighborhood House

San Francisco Real Estate Board

Retail Merchants Association

United Brotherhood of Carpenters and  
Joiners of America, Loc. 22

S. F. Federation of Art

S. F. Section National Council of  
Jewish Women

Women's Civic Center

California State Theatrical Federation

No. California Chapter, American  
Institute of Architects

S. F. Electrical Contractors Association, Inc.

Market Street Association

Steuben Society

East and West of Castro Street  
Improvement Club

---

**For Public Health and City's Growth**





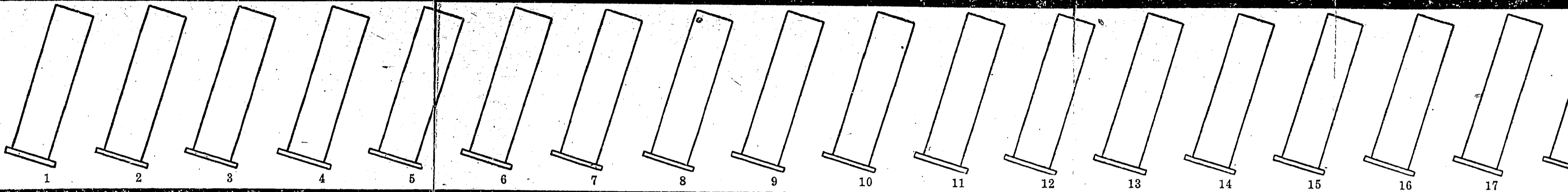

**SEWERS COME FIRST**

**Vote YES on Proposition No. 26**







(19)  
SAMPLE BALLOT



State Propositions,  
Constitutional  
Amendments, etc.  
Vote YES or NO

 Proposition <b>FOR 1 AGAINST</b> THE VETERANS BOND ACT OF 1943. This act provides for a bond issue of thirty million dollars (\$30,000,000) to be used by the Veterans' Welfare Board in assisting California war veterans to acquire farms or homes.	 Proposition <b>YES 2 NO</b> TAXATION. VETERANS EXEMPTION. Assembly Constitutional Amendment No. 1. Amends section 1 1/4, Article XIII, Constitution. Extends veterans exemption from property tax to persons serving in armed forces of United States who were previously honorably discharged after prior service.	 Proposition <b>YES 3 NO</b> CONSTITUTIONAL OFFICERS. COMPENSATION. Senate Constitutional Amendment No. 29. Authorizes Legislature to fix, at not less than \$5000 per annum, compensation of Lieutenant Governor, Controller, Secretary of State, Superintendent of Public Instruction, and Treasurer.	 Proposition <b>YES 4 NO</b> TAXATION. EXEMPTION OF RELIGIOUS, HOSPITAL AND CHARITABLE ORGANIZATIONS. Assembly Constitutional Amendment No. 17. Authorizes Legislature to exempt from taxes property used for religious, hospital, or charitable purposes and owned by agencies not conducted for profit.	 Proposition <b>YES 5 NO</b> PUBLIC OFFICERS AND EMPLOYEES. REINSTATEMENT AFTER MILITARY SERVICE. Senate Constitutional Amendment No. 10. Adds section 3.5 to Article XX Constitution to permit Legislature to provide for reinstatement of public officers and employees who resign to serve in armed forces of United States and this State.	 Proposition <b>YES</b> LEGISLATURE. Senate Constitutional Amendment No. 10. Amends section 3.5 of Constitution to permit Legislature to provide for reinstatement of public officers and employees who resign to serve in armed forces of United States and this State.
---	---	--	--	---	---

City and County  
Bond Propositions and  
Charter Amendments  
Vote YES or NO

 PROPOSITION <b>YES 26 NO</b> SEWER BONDS, 1944. To incur a bonded indebtedness in the sum of \$12,000,000 for constructing new and reconstructing old sewers, and sewage disposal plants, within the city and county.	 PROPOSITION <b>YES 27 NO</b> JUVENILE HOME AND COURT BONDS, 1944. To incur a bonded indebtedness in the sum of \$1,250,000 for the construction of buildings for uses of a Juvenile Detention Home, with meeting, court rooms and offices and the necessary lands therefor.	 CHARTER AMENDMENT <b>YES 28 NO</b> PENSIONS OF RETIRED PERSONS. Amending section 163 of the charter to provide that penalties on pensioners engaging in gainful occupations shall be suspended for the war and six months thereafter.	 CHARTER AMENDMENT <b>YES 29 NO</b> CONFIDENTIAL SECRETARY FOR SUPERINTENDENT OF SCHOOLS. Amending section 136 of the charter to provide for the appointment of non-civil-service confidential secretary by Superintendent of Schools.	 CHARTER AMENDMENT <b>YES 30 NO</b> EMPLOYEES OF STEINHART AQUARIUM. Amending section 52 of the charter to provide that employees of the Steinhart Aquarium with certain exceptions shall be subject to Civil Service.	 CHARTER AMENDMENT <b>YES</b> TERM OF COMMISSIONERS. Amending section 52 of the charter to provide that members of the Steinhart Aquarium with certain exceptions shall be subject to Civil Service.
---	---	---	---	---	---











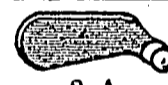



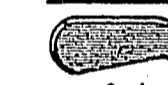
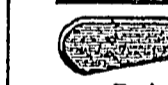
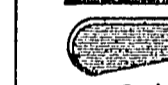
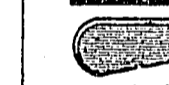
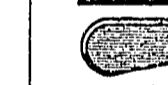
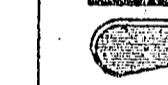
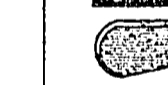





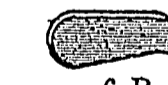

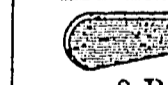

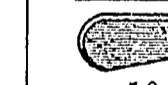

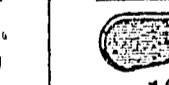
Vote for ONE Party

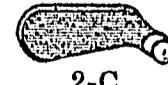
PRESIDENTIAL ELECTORS

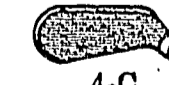
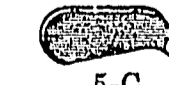
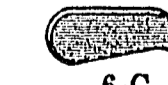
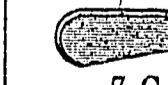
 **A**  
 THOMAS E. DEWEY for President  
 JOHN W. BRICKER for Vice President  
 REPUBLICAN PARTY

 **B**  
 FRANKLIN DELANO ROOSEVELT for President  
 HARRY S. TRUMAN for Vice President  
 DEMOCRATIC PARTY

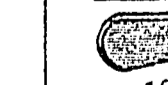
 **C**  
 CLAUDE A. WATSON for President  
 ANDREW JOHNSON for Vice President  
 PROHIBITION PARTY

 1-A	 2-A	 3-A	 4-A	 5-A	 6-A	 7-A	 8-A	 9-A	 10-A	 11-A	 12-A	 13-A
 1-B	 2-B	 3-B	 4-B	 5-B	 6-B	 7-B	 8-B	 9-B	 10-B	 11-B	 12-B	 13-B
 1-C	 2-C	 3-C	 4-C	 5-C	 6-C	 7-C	 8-C	 9-C	 10-C	 11-C	 12-C	 13-C



FOR VOTING FOR PERSONS NOT NOMINATED

17	18	19	20	21	22	23	24	25	26	27	28	29	30	31	32	33	34	35	36	37
----	----	----	----	----	----	----	----	----	----	----	----	----	----	----	----	----	----	----	----	----

**Proposition 6**  
**YES** **NO**  
**LEGISLATURE. SESSIONS. BUDGET.** Senate Constitutional Amendment No. 25. Amends sections 2 and 34 of Article IV Constitution, to provide for annual session of Legislature of not to exceed sixty days and for annual State Budget.

**Proposition 7**  
**YES** **NO**  
**LEGISLATURE. EXPENSES OF MEMBERS.** Assembly Constitutional Amendment No. 2. Adds section 23b to Article IV, Constitution, to authorize payment of expenses incurred by legislators in attending sessions.

**Proposition 8**  
**YES** **NO**  
**VALIDATING TAX DEEDS.** Senate Constitutional Amendment No. 21. Adds section 5 to Article XIII, Constitution. Raises conclusive presumption of validity of tax deeds, unless declared invalid in action commenced within one year after date of deed, or date of amendment, whichever is later.

**Proposition 9**  
**YES** **NO**  
**FUNDS FOR ELEMENTARY SCHOOLS.** Initiative Constitutional Amendment. Amends section 15, Article XIII. Increases revenue to be raised and apportioned by Legislature for public elementary schools.

**Proposition 10**  
**YES** **NO**  
**COMPENSATION OF OFFICERS, INCREASE DURING TERM.** Senate Constitutional Amendment No. 1. Amends section 5, Article XI, Constitution. Authorizes Legislature to suspend for duration prohibition against increasing compensation of officer.

**Proposition 11**  
**YES** **NO**  
**RETIREMENT PAYMENTS, GROSS INCOME TAX.** Initiative Constitutional Amendment. Adds Article XXX providing \$60 monthly payments to eligible citizens, over sixty, disabled, or blind. Provides 3 per cent gross income tax.

**Proposition 12**  
**YES**  
**RIGHT OF EMPLOYMENT.** Initiative Constitutional Amendment. Adds Article I. Declares free from interference or non-merit. Provides

**CHARTER AMENDMENT**  
**YES 31 NO**  
**TERM OF OFFICE OF RECREATION COMMISSION.** Amending section 42 of the charter providing term of office of members of Recreation Commission (except ex-officio) shall be four years.

**CHARTER AMENDMENT**  
**YES 32 NO**  
**EMPLOYEES OF CITY ATTORNEY AND PUBLIC DEFENDER.** Adding a new section, 34.1, to the charter providing that employees of the offices of the City Attorney and the Public Defender (except attorneys) shall be subject to Civil Service.

**CHARTER AMENDMENT**  
**YES 33 NO**  
**REINSTATEMENT OF MUNICIPAL EMPLOYEES SERVING IN AMERICAN RED CROSS.** Adding a new section, 153.1, to the charter providing for reinstatement in municipal service of persons serving in Red Cross.

**CHARTER AMENDMENT**  
**YES 34 NO**  
**POLICE DEPARTMENT.** Adding Charter Section 168.1, prescribing retirement provisions for present and future members of Police Department.

**City and County Bond Propositions and Charter Amendments**

13	14	15	16	17	18	19	20	21	22	23	24	25
13-A	14-A	15-A	16-A	17-A	18-A	19-A	20-A	21-A	22-A	23-A	24-A	25-A
13-B	14-B	15-B	16-B	17-B	18-B	19-B	20-B	21-B	22-B	23-B	24-B	25-B
13-C	14-C	15-C	16-C	17-C	18-C	19-C	20-C	21-C	22-C	23-C	24-C	25-C

<b>UNITED STATES SENATOR</b> VOTE FOR ONE		<b>REPRESENTATIVE IN CONGRESS</b> 4th Congressional District VOTE FOR ONE	
26-A Sheridan Downey Democratic United States Senator	27-A Frederick F. Houser Republican Lieut. Governor of California	28-A Thomas Rolph Republican Incumbent	29-A Frank Haas Democrat

- 1st. Move RED HANDLED VOTING LEVER and LEAVE IT THERE.
- 2nd. TO VOTE FOR OR AGAINST AN AMENDMENT, CHARTER AMENDMENT, or bond, charter amendment or bond, TO VOTE FOR ALL OF THE ELECTED names of the PRESIDENTIAL AND VICE PRESIDENTIAL CANDIDATES and leave it down, thus voting for candidates.
- 3rd. TO VOTE FOR PRESIDENTIAL AND VICE PRESIDENTIAL CANDIDATES FOR PRESIDENT AND VICE PRESIDENT ON THE BALLOT LABEL CARD, OR TO VOTE FOR PRESIDENTIAL AND VICE PRESIDENTIAL CANDIDATES ON THE VOTING MACHINE UNDER THE BALLOT LABEL CARD, WRITE NAMES OF THOSE FOR WHOM YOU WANT TO VOTE.
- 4th. TO VOTE FOR PRESIDENTIAL AND VICE PRESIDENTIAL CANDIDATES ON THE VOTING MACHINE UNDER THE BALLOT LABEL CARD, SLIDE AT TOP OF VOTING MACHINE.

# GENERAL ELECTION NOVEMBER 7, 1944

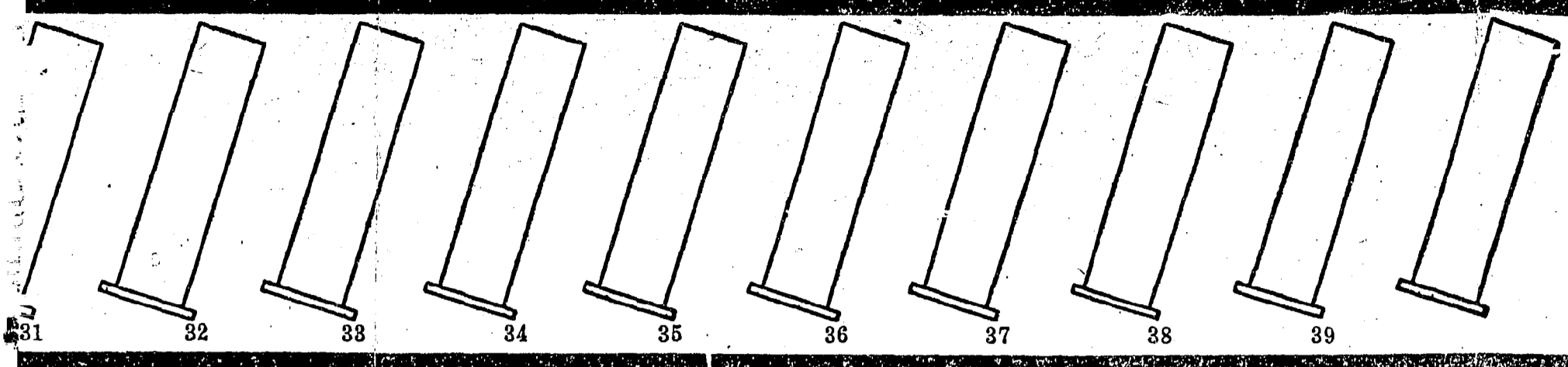

<p>Proposition 10 <b>NO</b></p> <p><b>ION OF OFFICERS, IN- RING TERM.</b> Senate Consti- tutional Amendment No. 1. Amends sec- tion XI, Constitution. Authorizes suspend for duration prohibi- increasing compensation of</p>	<p>Proposition 11 <b>YES</b></p> <p><b>RETIREMENT PAYMENTS, GROSS IN- COME TAX.</b> Initiative Constitutional Amendment. Adds Article XXX providing \$60 monthly payments to eligible citizens, over sixty, disabled, or blind. Provides 3 per cent gross income tax.</p>	<p>Proposition 12 <b>NO</b></p> <p><b>RIGHT OF EMPLOYMENT.</b> Initiative Con- stitutional Amendment. Adds section 1A to Article I. Declares right of employment free from interference because of member- ship or non-membership in labor organiza- tion. Provides remedy for interference.</p>
---	---	--

State  
Propositions

**STUDY SAMPLE  
BALLOT CAREFULLY  
SO WHEN YOU GO  
TO VOTE YOU CAN  
VOTE WITHOUT  
DELAY**

**POLLS OPEN 7 A. M. — CLOSE 8 P. M. VOTE EARLY.  
DON'T WAIT UNTIL THE LAST MINUTE.**

## City and County Bond Propositions and Charter Amendments

<p>24</p> <p>24-A</p>	<p>25</p> <p>25-A</p>	<p>26</p> <p>26-A</p> <p><b>Sheridan Downey</b> Democratic United States Senator</p>	<p>27</p> <p>27-A</p> <p><b>Frederick F. Houser</b> Republican Lieut. Governor of California</p>	<p>28</p> <p>28-A</p> <p><b>Thomas Rolph</b> Republican Incumbent</p>	<p>29</p> <p>29-A</p> <p><b>Franck R. Havener</b> Democratic</p>	<p>30</p> <p>30-A</p> <p><b>Bernard R. Brady</b> Democratic Incumbent</p>	<p>31</p> <p>31-A</p> <p><b>Edgar C. Levey</b> Republican Attorney at Law</p>	<p>32</p> <p>32-A</p> <p><b>YES</b></p> <p>Shall <b>B. Rey Schauer</b> be elected to the office for the term prescribed by law?</p>	<p>33</p> <p>33-A</p> <p><b>NO</b></p> <p>Shall <b>B. Rey Schauer</b> be elected to the office for the term prescribed by law?</p>	<p>34</p> <p>34-A</p> <p><b>YES</b></p> <p>Shall <b>Homer R. Spence</b> be elected to the office for the term prescribed by law?</p>	<p>35</p> <p>35-A</p> <p><b>NO</b></p> <p>Shall <b>Homer R. Spence</b> be elected to the office for the term prescribed by law?</p>	<p>36</p> <p>36-A</p> <p><b>Alfred J. Fritz</b> Superior Court Judge</p>	<p>37</p> <p>37-A</p> <p><b>Twain Michelsen</b> Judge of the Municipal Court</p>	<p>38</p> <p>38-A</p> <p><b>YES</b></p> <p><b>Adrien J. Falk</b></p>	<p>39</p> <p>39-A</p> <p><b>NO</b></p> <p><b>Adrien J. Falk</b></p>
-----------------------	-----------------------	--	--	---	--	---	---	---	--	--	---	--	--	--	---

### DIRECTIONS FOR VOTING

- 1st. Move **RED HANDLED VOTING LEVER** of MACHINE to the **RIGHT** as far as it will go and **LEAVE IT THERE.**
- 2nd. **TO VOTE FOR OR AGAINST ANY QUESTION, PROPOSITION, CONSTITUTIONAL AMENDMENT, CHARTER AMENDMENT OR BOND ISSUE,** pull down the **POINTER** over the word **"YES"** or **"NO,"** over each question, proposition, constitutional amendment, charter amendment or bond issue and **LEAVE IT DOWN.**
- 3rd. **TO VOTE FOR ALL OF THE ELECTORS OF A PARTY** pull down the **POINTER** over the names of the **PRESIDENTIAL AND VICE-PRESIDENTIAL CANDIDATES** of that party and leave it down, thus voting for all of the electors of that party and no others.
- 4th. **TO VOTE FOR PRESIDENTIAL ELECTORS WHO ARE NOT PLEDGED TO ANY OF THOSE CANDIDATES FOR PRESIDENT AND VICE PRESIDENT WHOSE NAMES ARE PRINTED ON THE BALLOT LABEL CARD, DO NOT TOUCH A POINTER ANYWHERE ON THE VOTING MACHINE UNDER THE DESIGNATION "PRESIDENTIAL ELECTORS," BUT WRITE NAMES OF THOSE FOR WHOM YOU DESIRE TO VOTE ON PAPER UNDER SLIDES AT TOP OF VOTING MACHINE NUMBERED FROM 1 TO 25 INCLUSIVE.**
- 5th. After voting for **PRESIDENTIAL AND VICE-PRESIDENTIAL CANDIDATES** proceed to candidates for other offices on **LINE A** and pull down **POINTER** over your choice for United States Senator, Representative in Congress and Member of Assembly; also over **"YES"** or **"NO"** for election of Associate Justice of the Supreme Court and Associate Justice of District Court of Appeal; also over **"YES"** or **"NO"** for confirmation of Member of Board of Education; also over your choice for Judge of the Superior Court Office No. 6.
- 6th. **TO VOTE FOR A PERSON FOR ANY OFFICE, OTHER THAN PRESIDENTIAL ELECTOR, WHOSE NAME DOES NOT APPEAR ON THE BALLOT LABEL CARD** (write in candidate), do not touch a pointer over the name of any candidate for the office for which you wish to write in the name of a candidate, but **RAISE NUMBERED SLIDE AT TOP OF VOTING MACHINE CORRESPONDING WITH NUMBER OF OFFICE ON OFFICE TITLE CARD, AND WRITE NAME YOU DESIRE ON PAPER UNDER SLIDE.**
- 7th. **LEAVING** the pointers as you have placed them (**DOWN** in the voting position), move the **RED HANDLE** of the MACHINE to the **LEFT** as far as it will go and you have voted and your vote registered.

