

# CITY and COUNTY PROPOSITIONS

To be voted on at the  
GENERAL ELECTION  
TUESDAY, NOVEMBER 8, 1960



Published under provisions of Section 183 of the  
Charter of the City and County of San Francisco.

*Thos. A. Toomey,*  
Registrar of Voters.

## SPECIAL NOTE:

In order to avoid congestion and possible delay at the polls on election day voters are urged to:

1. **USE THE POLLING PLACE CARD** enclosed herewith. Mark your choices for the various offices and propositions. **TAKE THE CARD WITH YOU TO THE POLLS** and you can complete your voting in less than **ONE MINUTE**.

2. Vote early, if possible.

**THOS. A. TOOMEY,**  
Registrar of Voters.

Permanent registration is maintained by **VOTING**.  
Voters who fail to vote at this election will have their  
registration **CANCELLED**.

# INDEX

Proposition	Page
A — Sewer Bonds, 1960, \$12,500,000 .....	5
B — Charter Amendment relating to terms of office of Mayor.....	9
C — Charter Amendment relating to preservation of local government in event of a disaster .....	10
D — Charter Amendment relating to periodic adjustment of certain retirement allowances .....	13
E — Charter Amendment relating to appointment of Assistant Librarian .....	18
F — Charter Amendment relating to engineering functions of Recrea- tion and Park Department .....	22
G — Charter Amendment relating to adjustment in certain retirement allowances .....	25
H — Ordinance relating to Water Department properties at Pleasanton..	28

(Requests for "Absent Voter's Ballot" must  
be received not later than November 3rd.)

## PROPOSITION A

**Sewer Bonds, 1960. To incur a bonded indebtedness in the sum of \$12,500,000 for the acquisition, construction and completion of buildings, lands, structures, and all other works, properties and appurtenances necessary or useful for sewage collection and disposal.**

FILE NO. 465-60-3

ORD. NO. 437-60

CALLING AND PROVIDING FOR A SPECIAL ELECTION TO BE HELD IN THE CITY AND COUNTY OF SAN FRANCISCO ON TUESDAY, NOVEMBER 8, 1960, FOR THE PURPOSE OF SUBMITTING TO THE VOTERS OF THE CITY AND COUNTY OF SAN FRANCISCO A PROPOSITION TO INCUR A BONDED DEBT OF THE CITY AND COUNTY TO THE AMOUNT OF \$12,500,000 FOR THE ACQUISITION, CONSTRUCTION AND COMPLETION BY THE CITY AND COUNTY OF SAN FRANCISCO OF THE FOLLOWING MUNICIPAL IMPROVEMENT, TO WIT: ADDITIONS AND BETTERMENTS TO THE EXISTING SEWAGE DISPOSAL AND TREATMENT PLANTS, NEW SEWERS, OUTFALL SEWERS, COLLECTING SYSTEMS, REPLACEMENT OF EXISTING SEWERS, LANDS, EASEMENTS, RIGHTS OF WAY, BUILDINGS, AND ALL OTHER WORKS, PROPERTIES OR STRUCTURES NECESSARY OR CONVENIENT FOR THE IMPROVEMENT OF THE SEWAGE TREATMENT AND DISPOSAL SYSTEM OF THE CITY AND COUNTY OF SAN FRANCISCO, AND THAT THE ESTIMATED COST TO THE CITY AND COUNTY OF SAID MUNICIPAL IMPROVEMENT IS AND WILL BE TOO GREAT TO BE PAID OUT OF THE ORDINARY ANNUAL INCOME AND REVENUE OF THE CITY AND COUNTY AND WILL REQUIRE AN EXPENDITURE GREATER THAN THE AMOUNT ALLOWED THEREFOR BY THE ANNUAL TAX LEVY; ALL IN ORDER TO DO AND PERFORM ANY AND ALL OF THE MATTERS HEREINABOVE REFERRED TO FOR SEWAGE DISPOSAL PURPOSES; FIXING RATE OF INTEREST OF SAID BONDS AND PROVIDING FOR THE LEVY AND COLLECTION OF TAXES TO PAY BOTH PRINCIPAL AND INTEREST THEREOF, PRESCRIBING NOTICE TO BE GIVEN OF SUCH ELECTION AND CONSOLIDATING THE SPECIAL ELECTION WITH THE GENERAL ELECTION.

Be it ordained by the People of the City and County of San Francisco:

Section 1. A special election is hereby called and ordered to be held in the City and County of San Francisco on Tuesday, the 8th day of No-

vember, 1960, for the purpose of submitting to the electors of said city and county a proposition to incur a bonded indebtedness of the City and County of San Francisco in the principal amount of \$12,500,000 for the acquisition, construction and completion by the City and County of San Francisco of the following municipal improvement, to wit: Additions and betterments to the existing sewage disposal and treatment plants, new sewers, outfall sewers, collecting systems, replacement of existing sewers, lands, easements, rights of way, buildings, and all other works, properties or structures necessary or convenient for the improvement of the sewage treatment and disposal system of the City and County of San Francisco.

Section 2. The estimated cost of the municipal improvement described herein was fixed by the Board of Supervisors by Resolution No. 487-60, passed by more than two-thirds of said board, and approved by the Acting Mayor in the sum of \$12,500,000, and such sum is, and was found by said resolution to be, too great to be paid out of the ordinary annual income and revenue of the city and county, in addition to the other annual expenses thereof or other funds derived from taxes levied for that purpose and will require an expenditure greater than the amount allowed therefor by the annual tax levy.

The method and manner of payment of the estimated cost of the municipal improvement described herein are by the issuance of bonds of the City and County of San Francisco in the principal amount specified in Section 1 hereof.

Section 3. The special election hereby called and ordered to be held shall be held and conducted and the votes thereat received and canvassed, and the returns thereof made and the result thereof ascertained, determined and declared as herein provided and in all particulars not herein recited said election shall be held according to the laws of the State of California providing for and governing elections in the City and County of San Francisco, and the polls for such election shall be and remain open during the time required by said laws.

Section 4. The said special election hereby called shall be and hereby is consolidated with the General Election to be held Tuesday, November 8, 1960, and the voting precincts, polling places and officers of election for said General Election be and the same are hereby adopted, established, designated and named, respectively, as the voting precincts, polling places and officers of election for said special election hereby called, and as specifically set forth by the Registrar of Voters of polling places and election officers for the said General Election.

The ballots to be used at said special election shall be the ballots to be used at said General Election and reference is hereby made to the notice of election setting forth the voting precincts, polling places and officers of election by the Registrar of Voters for the General Election to be published in the San Francisco Chronicle on or about October 21, 1960.

Section 5. On the ballots to be used at such special election and on the voting machines used at said special election, in addition to any other

matter required by law to be printed thereon, shall appear thereon the following:

"Sewer Bonds, 1960. To incur a bonded indebtedness in the sum of \$12,500,000 for the acquisition, construction and completion of buildings, lands, structures, and all other works, properties and appurtenances necessary or useful for sewage collection and disposal."

To vote for the proposition where ballots are used, and to incur the bonded indebtedness to the amount of and for the purposes stated herein, stamp a cross (X) in the blank space to the right of the word "Yes." To vote against the proposition and thereby refuse to authorize the incurring of a bonded indebtedness to the amount of and for the purposes stated herein, stamp a cross (X) in the blank space to the right of the word "No."

Where voting machines are used at said special election the said voting machines shall be so arranged that any qualified elector may vote for the proposition by pulling down a lever over the word "Yes" under or near a statement of the proposed proposition appearing on cardboard, paper or other material placed on the front of the machine and said act shall constitute a vote for the proposition, and by pulling down a lever over the word "No" under or near a statement of the proposed proposition appearing on cardboard, paper or other material placed on the front of the machine, shall constitute a vote against the proposition. Said voting machines and the preparation of the same shall comply in all respects with the provisions of law.

Section 6. If at such special election it shall appear that two-thirds of all the voters voting on said proposition voted in favor of and authorized the incurring of a bonded indebtedness for the purposes set forth in said proposition, then such proposition shall have been accepted by the electors, and bonds shall be issued to defray the cost of the municipal improvement described herein. Such bonds shall be of the form and character known as "serials," and shall bear interest at a rate not to exceed 6 per centum per annum, payable semiannually.

Section 7. For the purpose of paying the principal and interest on said bonds, the Board of Supervisors shall, at the time of fixing the general tax levy and in the manner for such general tax levy provided, levy and collect annually each year until such bonds are paid, or until there is a sum in the Treasury of said city and county set apart for that purpose to meet all sums coming due for the principal and interest on said bonds, a tax sufficient to pay the annual interest on such bonds as the same become due and also such part of the principal thereof as shall become due before the proceeds of a tax levied at the time for making the next general tax levy can be made available for the payment of such principal.

Section 8. This ordinance shall be published once a day for at least seven (7) days in the San Francisco Chronicle, a newspaper published daily in the City and County of San Francisco, being the official newspaper of said city and county and such publication shall constitute notice of said election and no other notice of the election hereby called need be given.

Approved as to form.

DION HOLM, City Attorney

Passed for Second Reading — Board of Supervisors, San Francisco, August 15, 1960.

Ayes: Supervisors Casey, Dobbs, Ertola, Ferdon, Halley, McMahon, J. Joseph Sullivan, James J. Sullivan.

ROBERT J. DOLAN, Clerk

Read Second Time and Finally Passed — Board of Supervisors, San Francisco, August 22, 1960.

Ayes: Supervisors Blake, Ertola, Ferdon, Halley, McMahon, J. Joseph Sullivan, James J. Sullivan, Zirpoli.

I hereby certify that the foregoing ordinance was finally passed by the Board of Supervisors of the City and County of San Francisco.

ROBERT J. DOLAN, Clerk

Approved August 23, 1960.

GEORGE CHRISTOPHER, Mayor

## ARGUMENT FOR PROPOSITION A

### Sewer Bonds

#### Vote Yes On Proposition A

Proposition A authorizes the issuance of bonds in the amount of \$12,500,000 for expansion and certain necessary replacements of San Francisco's sewer and sewage treatment plant system.

It is necessary that certain improvements be made immediately in order to keep pace with new housing and industrial growth, to replace badly worn facilities, and to meet increasingly rigid requirements of State and Federal agencies relative to operational safety and pollution of the Bay.

#### Vote Yes On Proposition A

San Franciscans have good reason to be proud of the service, convenience and health protection afforded by their sanitary and storm sewers and sewage treatment plants. Although one of the most modern and efficient such systems in the Nation, nevertheless capital costs must from time to time be incurred.

The \$12,500,000 in bond funds will provide for improvements to the three sewage treatment plants and for collection systems, extensions, enlargements and replacements in various sections of the city.

#### Vote Yes On Proposition A

The building of new homes, particularly in the westerly section of the city; industrial expansion, such as in the tidelands reclamation areas; additional new housing, and redevelopment projects, underscore the urgency of action now in providing for necessary sewer extensions, and enlargements of sewer lines and treatment plants. Some sewer lines have deteriorated through heavy use and age to the point where they must be replaced. Flooding in many sections of the city during storms indicates another reason sewer main enlargements must be made and made soon.

#### Vote Yes On Proposition A

Your "yes" vote on Proposition A will provide the necessary funds for sewer and sewage treatment system expansion and replacements for which there is critical need. Your "yes" vote will spread the cost for these necessary improvements over a period of years.

Finally, your support in providing your city with an adequate, efficient sewer and sewage treatment system is an investment in the health and welfare of yourself and your fellow citizens.

**Vote Yes On Proposition A**

The following, among many others, urge you to vote YES on Proposition A:

GEORGE CHRISTOPHER, Mayor	San Francisco Building and Construction Council
SHERMAN P. DUCKEL, Chief Administrative Officer	Associated Sportsmen of California
San Francisco Municipal Conference	San Francisco Labor Council A.F.L.-C.I.O.
San Francisco Chamber of Commerce	

On August 29, 1960, the Board of Supervisors authorized the foregoing argument for inclusion in the election pamphlet for November 8, 1960, by the following vote:

Ayes: Supervisors Blake, Dobbs, Ertola, Ferdou, Halley, McMahon, J. Joseph Sullivan, James J. Sullivan, Zirpoli.

ROBERT J. DOLAN, Clerk

**CONTROLLER'S STATEMENT PURSUANT TO CHARTER SECTION 183  
PROPOSITION "A"**

**Sewer Bonds, 1960**

To incur a bonded indebtedness in the sum of \$12,500,000 for the acquisition, construction and completion of buildings, lands, structures, and all other works, properties and appurtenances necessary or useful for sewage collection and disposal.

Should the proposed \$12,500,000 Sewer Bonds, 1960, be authorized, and when all bonds shall have been issued on a 15 year basis, and after consideration of the interest rates related to current municipal bond sales, and using the 1960-61 assessment roll as the basis for calculating the effect upon the tax rate, in my opinion, the approximate cost and effect on the tax rate would be as follows:

Bond redemption .....	\$12,500,000
Interest requirement .....	3,250,000
Total debt service requirement .....	<u>\$15,750,000</u>
Average annual debt service requirement for 15 years .....	<u>\$ 1,050,000</u>

\$1,050,000 is equivalent, in the tax rate, to  
seven and three tenths cents ..... (\$0.073)

HARRY D. ROSS, Controller  
City and County of San Francisco

**CHARTER AMENDMENT  
PROPOSITION B**

**Repeals Charter Section 5.1. Eliminates limitation of two successive terms for any one person to serve as Mayor.**

Describing and setting forth a proposal to the qualified electors of the City and County of San Francisco to amend the charter of said city and

county by repealing Section 5.1 thereof, relating to terms of office of the Mayor.

The Board of Supervisors of the City and County of San Francisco hereby submits to the qualified electors of said city and county at an election to be held therein on November 8, 1960, a proposal to amend the charter of said city and county by repealing Section 5.1 thereof. Said section now reads as follows:

NOTE: Deletions are indicated by ((double parentheses)).

((Section 5.1. No person elected as mayor shall be eligible to serve or serve, as such for more than two successive terms; but such service shall not disqualify any person for further service as mayor for any term or terms which are not successive, nor for any parts of terms which are not successive.))

Ordered submitted — Board of Supervisors, San Francisco, April 25, 1960.

Ayes: Supervisors Dobbs, McMahon, Rolph, J. Joseph Sullivan, James J. Sullivan, Zirpoli.

Noes: Supervisors Blake, Casey, Ertola, Ferdon, Halley.

I hereby certify that the foregoing charter amendment was ordered submitted by the Board of Supervisors of the City and County of San Francisco.

ROBERT J. DOLAN, Clerk

## CHARTER AMENDMENT PROPOSITION C

**Amends Charter Sections 9 and 25. Provides method of succession in event of disaster for office of Mayor, grants Board of Supervisors powers conferred by State law pertaining to preservation of local government.**

Describing and setting forth a proposal to the qualified electors of the City and County of San Francisco to amend the charter of said city and county by amending Sections 9 and 25 thereof, relating to the preservation of local government in the event of a disaster by providing for the succession to the office of mayor and vesting in the board of supervisors those powers conferred by the general law of the state pertaining to the preservation of local government.

The board of supervisors of the City and County of San Francisco hereby submits to the qualified electors of said city and county at an election to be held therein on November 8, 1960, a proposal to amend the charter of said city and county by amending Sections 9 and 25 thereof, so that the same shall read as follows:

NOTE: Additions or substitutions are indicated by bold-face type; deletions are indicated by ((double parentheses)).



## Powers Vested In Board of Supervisors

Section 9. The powers of the city and county, except the powers reserved to the people or delegated to other officials, boards or commissions by this charter, shall be vested in the board of supervisors and shall be exercised as provided in this charter. The board of supervisors shall, ex officio, be the board of equalization for the city and county. The supervisors shall determine the maximum number of each class of employment in each of the various departments and offices of the city and county and shall fix rates and schedules of compensation therefor in the manner provided in this charter. On the recommendation of the mayor and the chief administrative officer, the board of supervisors may create or abolish departments which are now or may hereafter be placed under the chief administrative officer or under commissions appointed by the mayor.

The board of supervisors may, by ordinance, confer on any officer, board or commission such other and additional powers as the board may deem advisable.

The board of supervisors, by ordinance, may provide medical care, hospitalization, compensation and such other benefits as the board may deem necessary for regularly authorized volunteer civilian defense workers suffering injury arising out of and in the course of their activities as such civilian defense workers.

To provide for the continuance or restoration of local government in the event of a disaster which renders unavailable a majority of its members, the board of supervisors shall have those powers that are conferred by the general law of the State of California pertaining to the preservation of local government, notwithstanding anything to the contrary contained in this charter.

## POWERS AND DUTIES OF ELECTIVE OFFICERS

### The Mayor

Section 25. The mayor shall be the chief executive officer of the city and county upon whom process issued by authority of law shall be served. He shall be an elective officer and his compensation shall be fixed in accordance with the salary standardization provisions of this charter. He shall furnish an official bond in the sum of twenty-five thousand dollars (\$25,000). He shall appoint, and at his pleasure may remove, an executive secretary and one confidential secretary, and one stenographer. The board of supervisors may annually appropriate additional sums to be expended by the mayor for purposes and duties incidental to the administration of the office of mayor, which shall be subject to the provisions of this charter relative to appropriations and the payment of claims. He shall, at the first meeting of the board of supervisors in October of each year, communicate by message to the supervisors a general statement of the condition of the affairs of the city and county, and recommend the adoption of such measures as he may deem expedient and proper.

The mayor shall be responsible for the enforcement of all laws relating to the municipality and for the review and submission of the annual executive budget; he shall supervise the administration of all departments under boards and commissions appointed by him; he shall receive and examine, without delay, all complaints relating to the administration of the affairs of the city and county, and immediately inform the complainant of findings

and actions thereon; and he shall co-ordinate and enforce co-operation between all departments of the city and county. The Mayor shall have power to postpone final action on any franchise that may be passed by the supervisors until such proposed franchise shall have been voted on at the next election.

The mayor shall appoint such members of boards or commissions and other officers as provided by this charter. He shall appoint for the unexpired term of the office vacated, a qualified person to fill any vacancy occurring in any elective office.

The mayor shall have a seat but no vote in the board of supervisors and in any board or commission appointed by him, with the right to report on or discuss any matter before such board or commission concerning the departments or affairs in his charge. He shall have power to designate a member of the board of supervisors to act as mayor in his absence. Should he fail, neglect or refuse so to do, the supervisors shall elect one of their number to act as mayor during his absence. When a vacancy occurs in the office of mayor, it shall be filled for the unexpired portion of the term by the supervisors. In case of a disaster which causes the mayor to be absent or unavailable and the supervisors for any reason whatsoever are unable to elect one of their number to act as mayor or to fill any vacancy that might occur in the office of mayor, the following persons shall act as mayor in the order of succession hereinafter designated: (1) president of the board of supervisors, (2) chairman of the finance committee of the board of supervisors, (3) senior member of the board of supervisors, who is that member having the greatest number of years of service as a member of the board, and in the event that one or more members have equal seniority then by alphabetical order of surname among such members, and (4) chief administrative officer. Said person so designated shall act as mayor during such period of absence or unavailability of the mayor until such time as the supervisors can take appropriate action either to elect an acting mayor or to fill the vacancy as the case may be. Every person who has served as mayor of the city and county, so long as he remains a resident thereof, shall have a seat in the board of supervisors and may participate in its debates, but shall not be entitled to a vote or to compensation.

In case of a public emergency involving or threatening the lives, property or welfare of the citizens, or the property of the city and county, the mayor shall have the power, and it shall be his duty, to summon, organize and direct the forces of any department in the city and county in any needed service; to summon, marshal, deputize or otherwise employ other persons, or to do whatever else he may deem necessary for the purpose of meeting the emergency. The mayor may make such studies and surveys as he may deem advisable in anticipation of any such emergency.

Ordered submitted — Board of Supervisors, San Francisco, August 22, 1960.

Ayes: Supervisors Blake, Dobbs, Ertola, Ferdon, Halley, James J. Sullivan, Zirpoli.

Noes: Supervisors McMahon, J. Joseph Sullivan.

I hereby certify that the foregoing charter amendment was ordered submitted by the Board of Supervisors of the City and County of San Francisco.

ROBERT J. DOLAN, Clerk

# CHARTER AMENDMENT

## PROPOSITION D

**Adds Sections 165.5 and 168.4 to Charter. Provides for periodic adjustment in retirement allowance in direct proportion to changes in the earnable salaries of members.**

Describing and setting forth a proposal to the qualified electors of the City and County of San Francisco to amend the charter of said city and county by adding Sections 165.5 and 168.4 thereto, to provide for adjustments in retirement allowances of miscellaneous employees who retire under Section 165 or 165.2, based on future changes in the aggregate earnable monthly salaries of members of the system under such sections, and policemen and firemen who retire or die under Sections 168.1 and 171.1, based on future changes in compensation earnable for rank or position held at retirement or death.

The Board of Supervisors of the City and County of San Francisco hereby submits to the qualified electors of said city and county at an election to be held therein on November 8, 1960, a proposal to amend the charter of said city and county by adding sections 165.5 and 168.4 thereto, reading as follows:

### Basis for Adjustments In Retirement Allowances of Miscellaneous Employees

**Section 165.5.** Every allowance payable under the San Francisco City and County Retirement System, to or on account of persons who retire on or after effective date of this amendment under section 165 or 165.2 shall be subject to adjustment as hereinafter set forth.

(1) Each such allowance shall be adjusted as hereinafter provided, on the basis of an increase or a decrease in the maximum earnable monthly compensation of members of the system under sections 165 and 165.2. Such adjustments in allowances shall be effective on July 1st following a period beginning on the first day of July of the year in which this section becomes effective, or the date on which such adjustment was last made, whichever is later, but such adjustment shall be made only if the amount of the adjustment calculated as provided in this section, in each allowance exceeds one per cent of such allowance. On any effective date of adjustment, each such adjusted allowance prior to adjustment shall bear the same ratio to the allowance after adjustment as the aggregate maximum earnable monthly salaries of the positions at the beginning of such period last held by persons who were members of the system under section 165 or 165.2 on such beginning date, bears to the aggregate maximum earnable monthly salaries of the same positions on said effective date, whether or not such positions are held by any employee on said effective date. No such allowance shall be decreased under the provisions of this section to an amount less than the amount of such allowance when first it became effective, or as it was immediately preceding the effective date of this section, whichever amount is the greater.

(2) Allowances granted under the provisions of paragraph (F) of section 165.2, shall not be subject to this section.

(3) Solely for the purpose of this section, the expression "compensation earnable" is hereby declared to apply only to a basic amount of salary or wages, and shall not include any differential for overtime, night or split shift, or any other premium pay differentials of any type whatever, and shall be taken as the compensation which would have been earnable if the employment had been on a full-time basis, and the employee had worked full time.

(4) The word "allowance" as used in this section means the allowance payable exclusive of the annuity provided by additional contributions.

(5) This section does not give any person retired prior to effective date hereof, or his successors in interest, any claim against the city and county for any increase or decrease in any retirement allowance paid or payable for time prior to said effective date.

(6) Not later than the last Monday of July of each year, the board of supervisors shall have power and it shall be its duty, subject to the fiscal provisions of the charter but, without reference or amendment to the annual budget, to amend the annual appropriation ordinance to include the provisions necessary for paying to the retirement system the contributions required of the city and county on account of the increases in monthly allowances provided in this section for the then current fiscal year, which shall not be less than the amount disbursed during that year on account of such increases.

#### Basis for Adjustments in Retirement or Death Benefits For Members of Fire and Police Departments

Section 168.4. (1) "Compensation" as used in this section with respect to members of the fire and police departments who retire or die, as members under section 168.1 or 171.1, after the effective date of this section, and as distinguished from benefits under the Workmen's Compensation Insurance and Safety Act of the State of California, shall mean the cash remuneration payable by the city and county, attached to the rank or position held by the member, without deduction except for absence from duty, but excluding remuneration paid for overtime. Any allowance based on such "compensation" shall be adjusted from time to time, as the compensation attached to such rank or position is changed, after the member's retirement or death.

(2) "Final compensation" as used in this section with respect to members of the fire and police departments who retire or die, as members under section 168.1 or 171.1, after the effective date of this section, shall mean the average monthly compensation attached to the rank or position held by the member during the three years immediately preceding his retirement, or death before retirement. Such "final compensation", and any allowance based on it, shall be adjusted from time to time and in the same ratio, as the compensation attached to the rank or position held at retirement or death is changed, after the member's retirement or death. No such allowance however, shall be decreased under the provisions of this section, to an amount less than the amount of such allowance when it first became effective, or as it was immediately preceding the effective date of this section, whichever amount is greater.

(3) The word "allowance" as used in this section means the allowance payable exclusive of the annuity provided by additional contributions, and with respect to the allowance payable to a retired person, his allowance prior to modification under an option provided by ordinance. If the retired person elected at his retirement to receive his allowance under option 2 or 3, provided by ordinance, and if at the effective date of any increase or decrease in such allowance provided by this section, the retired person and the beneficiary named by him under such option are both living, such increase or decrease shall be modified under the option elected at retirement, and on the basis of current ages, mortality tables, and interest rate. If the beneficiary of such a person who elected at retirement to have his allowance modified under one of said options is not living on said effective date, or if the retired member is not living on said effective date and the beneficiary is receiving the modified retirement allowance, then the allowance shall be increased or decreased as provided herein for persons who did not elect an option.

(4) Not later than the last Monday of July of each year, the board of supervisors shall have power and it shall be its duty, subject to the fiscal provisions of the charter, but, without reference or amendment to the annual budget, to amend the annual appropriation ordinance to include the provisions necessary for paying to the retirement system the contributions required of the city and county on account of the increases in monthly allowances provided in this section for the then current fiscal year, which shall not be less than the amount disbursed during that year on account of such increases.

Ordered submitted — Board of Supervisors, San Francisco, Sept. 6, 1960.

Ayes: Supervisors Blake, Casey, Dobbs, Ertola, Ferdon, Rolph, J. Joseph Sullivan, James J. Sullivan, Zirpoli.

No: Supervisor McMahon.

I hereby certify that the foregoing charter amendment was ordered submitted by the Board of Supervisors of the City and County of San Francisco.

ROBERT J. DOLAN, Clerk

#### ARGUMENT FOR PROPOSITION "D"

The retired employee is defenseless against the high cost of inflation. Each day, he sees his retirement allowance buy less and less; each day, he is compelled to scrimp a little harder to stretch his monthly check over the necessities of life.

Perhaps worse than that, the retired employee is cut off, isolated from any share or participation in rising living standards or in the growing prosperity of the community and of the nation. All around him, wages may be climbing but his own meager allowance remains the same.

Suppose you had retired half a dozen years ago after a quarter century or more of service. In just these half dozen years the value of your retirement allowance would have been cut close to 10%. Could you afford such a cut in your pay check? Could you, if you were retired, afford that loss in your living standard? Where would you cut? Food? Clothing? Medical Care?

Proposition "D" is intended to restore the retired city employee to a decent share in the community's progress and provide a measure of protection against inflation, consistent with his many years of contribution to our common welfare. It provides an increase in his retirement allowance in di-

rect proportion to a change in the salary of the position he held at the time of his retirement. It would apply only to employees who retire after the Charter Amendment becomes effective.

Fair-minded voters will immediately recognize the justice in this proposal. But there are those who see it solely as a question of taxes, and not as a problem involving live human beings. And yet even they cannot decently object on this score. The Employee's Retirement System's estimate of cost—assuming a 5% annual increase in pay—runs to \$9,850 for the first year, \$56,042 for the second year, \$140,305 for the third year, \$264,814 for the fourth year and \$431,305 for the fifth year. If there were no wage increase, there would be no cost. If there were a smaller increase, the cost would, of course, be correspondingly smaller.

It is plainly not a question of cost; rather, it is a question of fair play to the retired city employee, of helping him to maintain in retirement the life of dignity and security you would want for yourself.

### **V-o-t-e "Yes" on Proposition "D."**

Endorsed by:

San Francisco Labor Council, AFL-CIO.

George W. Johns, Secretary—San Francisco Labor Council.

William F. Murray, Chief of San Francisco Fire Department.

San Francisco Building and Construction Trades Council.

A. F. Mailloux, Secretary—S. F. Building and Construction Trades Council.

Board of Fire Commissioners.

On September 6, 1960, the Board of Supervisors authorized the foregoing argument for inclusion in the election pamphlet for November 8, 1960, by the following vote:

Ayes: Supervisors Blake, Casey, Dobbs, Ertola, Ferdon, Rolph, J. Joseph Sullivan, James J. Sullivan, Zirpoli.

No: Supervisor McMahon.

ROBERT J. DOLAN, Clerk

### **ARGUMENT AGAINST PROPOSITION "D"**

#### **Vote "No" on Proposition "D"—A Dangerously Costly Proposal**

Proposition "D" is probably the most costly pension scheme yet put up to the voters. Like other unsound pension proposals, "D" must be rejected with a resounding "NO" vote. A similar measure was defeated in 1958 by an overwhelming vote.

The promoters of Proposition "D" call this a "living pension" and play upon your sympathies for the "meager allowance" of the retired. They fail to tell you that "D" does not apply to presently retired employees. They also neglect to tell you about the handsome and costly benefits now granted. Policemen and firemen can retire at 55 after 25 years work. Other employees have the city retirement system and federal social security available to them.

Proposition "D" is a "time bomb" measure. Its low cost in the beginning could pyramid into staggering costs in the future. Note the rapid climb in costs in only 5 years in the controller's cost statement. The retirement system's actuarial report shows that the citizens may be liable for over \$360,000,000 in cost if this scheme is approved. It's a "time bomb" you can't stop

once it starts. Employees would probably sue for "vested rights" if this measure were passed and the voters tried to correct their mistake.

Don't be fooled by crocodile tears about the retired and inflation. Not a single presently retired person would be benefited. This measure is being promoted by current employees who want you to guarantee their future against inflation. Before voting, ask yourself who is guaranteeing your financial future. The retirement system is already costing taxpayers over \$14,000,000 a year without this blank check proposition.

**Vote "No" on "D." Defeat This Dangerous Pension Scheme.**

This argument is sponsored by The San Francisco Municipal Conference, composed of representatives of the following organizations:

Apartment House Associations  
Consolidated, Inc.  
Building Owners and Managers  
Association  
California Northern Hotel  
Association

Down Town Association  
San Francisco Chamber of Commerce  
S.F. Junior Chamber of Commerce  
San Francisco Real Estate Board

ARTHUR E. WILKENS, Chairman

**CONTROLLER'S STATEMENT PURSUANT TO CHARTER SECTION 183  
PROPOSITION "D"**

Charter amendment, adding sections 165.5 and 168.4 thereto, to provide for adjustments in retirement allowances of miscellaneous employees who retire under sections 165 and 165.2, based on future changes in the aggregate earnable monthly salaries of members of the system under such sections, and policemen and firemen who retire or die under sections 168.1 and 171.1, based on future changes in compensation earnable for rank or position held at retirement or death.

Should Proposition "D" be enacted, and based upon

(a) the present number of employees affected thereby,

(b) a report by the Employees' Retirement System, using for illustrative purposes increases in salaries of 1%, 3% and 5% compounded annually, and

if salaries are in fact increased by the percentages used in the Retirement System's report, the following table illustrates an estimated increase in costs over current costs and an estimated effect thereof upon the tax rate for the first five years. The 1960-61 assessment roll was used as a base for calculation of the effect of such illustrative costs upon the tax rate.

Fiscal Year	1%		3%		5%	
	Amount	Cents in Tax Rate	Amount	Cents in Tax Rate	Amount	Cents in Tax Rate
1961-62	\$ 1,970	0.0137	\$ 5,910	0.0412	\$ 9,850	0.0686
1962-63	11,130	0.0775	33,507	0.2334	56,042	0.3904
1963-64	28,551	0.1988	83,442	0.5813	140,305	0.9774
1964-65	51,306	0.3574	156,387	1.0894	264,814	1.8447
1965-66	82,467	0.5745	253,027	1.7626	431,305	3.0044

Because we cannot forecast the future salary adjustments, we have prepared the above calculations, projected for five years, only for the purpose of illustrating possible costs and the trend of such costs in the event the conditions used in the illustration become a reality.

HARRY D. ROSS, Controller  
City and County of San Francisco

# CHARTER AMENDMENT

## PROPOSITION E

**Amends Charter Section 43. Provides for appointment by Library Commission of Assistant Librarian to serve at its pleasure. Repeals obsolete language.**

Describing and setting forth a proposal to the qualified electors of the City and County of San Francisco to amend the charter of said city and county by amending Section 43 thereof, relating to the library department, to provide that the assistant city librarian shall hold office at the pleasure of the library commission.

The Board of Supervisors of the City and County of San Francisco hereby submits to the qualified electors of said city and county at an election to be held therein on November 8, 1960, a proposal to amend the charter of said city and county by amending Section 43 thereof so that the same shall read as follows:

NOTE: Additions or substitutions are indicated by **bold-face type**; deletions are indicated by ((double parentheses)).

### Library Department

Section 43. The library department shall be under the management of a library commission consisting of eleven members who shall be appointed by the mayor and shall serve without compensation.

The eleven library trustees constituting the board of library trustees in office at the time this charter shall go into effect shall, by lot, classify their respective terms of office so that three of such terms shall begin at twelve o'clock noon on the 15th day of January, 1932, 1933, and 1934, respectively, and two such terms shall begin at twelve o'clock noon on the 15th day of January, 1935. The term of each commissioner shall be four years, at the expiration of which the mayor shall appoint his successor.

The library commission shall appoint a librarian, an assistant city librarian and a secretary who shall hold office at its pleasure. The librarian shall be the chief executive of the department and shall be the appointing officer for the department as provided in section 20 of the charter.

((Commencing on the 1st day of January, 1942, all)) All positions in the library department except those of librarian, assistant city librarian and secretary of the library commission and part time services carrying compensation of less than ((\$80)) \$125 per month including valuation of maintenance or other allowances shall be subject to the civil service provisions of this charter. ((, and upon said date, any incumbent of such position in the library department, hereby made subject to civil service, who shall have held such position continuously for one year prior thereto, shall be deemed



appointed to such position under the civil service provisions of this charter.)

The library commission shall be the successors in office of the board of library trustees holding office at the time this charter shall go into effect and shall have all the powers and duties thereof, except as in this charter otherwise provided.

Ordered submitted — Board of Supervisors, San Francisco, September 6, 1960.

Ayes: Supervisors Blake, Dobbs, McMahon, Rolph, J. Joseph Sullivan, James J. Sullivan, Zirpoli.

Noes: Supervisors Casey, Ertola, Ferdon.

I hereby certify that the foregoing charter amendment was ordered submitted by the Board of Supervisors of the City and County of San Francisco.

ROBERT J. DOLAN, Clerk

### ARGUMENT FOR PROPOSITION "E"

This charter amendment creates the new position of Assistant City Librarian to serve at the pleasure of the Library Commission, exempted from the Civil Service provisions of the charter.

There would appear to be no opposition to the creation of the new position itself.

The only objection which has been advanced is that the position should not be exempted from Civil Service so that it may afford a promotional opportunity to career employees of the library system.

There are at present but two exempted positions in the library department, those of Librarian and Secretary of the Library Commission.

The Library Commission is in accord with the general philosophy of civil service and it is far from its intention to curtail promotional opportunities in the areas where the same are indicated.

However, this position does not fall in that category.

San Francisco citizens are increasingly demanding an expanded and improved library system. To obtain a blue-print for the expansion and improvement of the system, the Library Commission had a survey made by Emerson Greenaway, one of the top librarians in the United States and past president of the American Library Association. One of the main recommendations of the survey was the creation of this position in order to attain improved administration of the library system. Mr. Greenaway further recommended that the position be exempted from civil service.

The person holding the new position will be the principal assistant to the city librarian and will relieve him of much administrative detail, freeing him for the planning of the overall work and growth of the system. The position is primarily concerned with the improved administration of the library.

It is readily seen that this position does not establish a second level of authority but rather an expansion of the first level (that of librarian) to meet the demands required of the librarian under the already expanded system and the goals set by the blueprint of the Greenaway Report. So, as the librarian is exempted from Civil Service, it follows that the person who will be at the same administrative level should also be exempted. The appointee of this position must be completely compatible with the Librarian, and the Commission, and serve at the pleasure of the Commission. The theory of administration exemption from Civil Service is recognized in the charter.

The administration of our library system, now a multi-million dollar capital investment made by the people of San Francisco, with a present operating budget of over two million dollars and considerable increases indicated for the future, is by the charter placed under the management of the Library Commission. Good management dictates that this new administrative position shall be exempt from Civil Service so that it may be filled by the Commission and the appointee may serve at its pleasure. We urge you to support the Commission in its effort to put into effect the recommendations contained in the Greenaway Report to attain the demanded expanded and improved library system for the citizens of the City and County of San Francisco.

Vote YES.

Endorsed by:

San Francisco Library Commission.

J. Max Moore, former Library Commissioner and presently Co-Chairman, Mayor's Committee of Fifty.

Mrs. Hazel M. O'Brien, former Library Commissioner, who is secretary-treasurer of Waitresses Union, Local No. 48.

San Franciscans for a Better Library.

On September 6, 1960, the Board of Supervisors authorized the foregoing argument for inclusion in the election pamphlet for November 8, 1960, by the following vote:

Ayes: Supervisors Blake, Dobbs, McMahon, Rolph, J. Joseph Sullivan, James J. Sullivan, Zirpoli.

Noes: Supervisors Casey, Ertola, Ferdon.

ROBERT J. DOLAN, Clerk

## **ARGUMENT AGAINST PROPOSITION E**

Proposition E is a direct attack on our local civil service system and an open invitation to return to the repugnant, and often corrupt, "spoils system."

We in San Francisco have good reason to be proud of our civil service system, judged by many to be one of the finest in the country. One of the important reasons for its strength is that efforts to break it down, by bits-and-pieces legislation, have been vigorously resisted—by the Civil Service Commission, by the Supervisors, and by the people of San Francisco.

Proposition E is another such effort to drive a wedge into the city's merit system. Certainly, if the Library Commission were empowered to appoint an assistant city librarian outside the controls and regulations of civil service, every other city commission would promptly move to acquire the same power. The first serious disruption of civil service would have been achieved.

The Civil Service Commission, precisely for this reason, opposes this proposition and urges that the position be filled on the basis of examination and maintained under the merit system.

Proposition E defeats the career concept in public service. It closes the door on open competition on the basis of merit and qualifications. It threatens the continuity of operation and administration that is made possible by protected civil service.

But its greatest sin lies in the invitation it offers to progressive weakening of the civil service system by setting a precedent for the removal of still other city positions from the merit system.

We urge the voters of San Francisco to join with us and the Civil Service Commission in actively opposing this measure and in vigorously defending the merit system from attack.

We urge you to vote NO on Proposition E.

This argument is sponsored by the following organizations:

San Francisco Labor Council, GEO. W. JOHNS, Secretary

Civil Service Association of San Francisco, GRANVILLE DeMERRITT, Executive Secretary

San Francisco City and County Employees Union, Local 400, J. E. JEFFERY, Business Representative

## **CONTROLLER'S STATEMENT PURSUANT TO CHARTER SECTION 183 PROPOSITION "E"**

Charter amendment, amending section 43 thereof relating to the Library Department, to provide that the assistant city librarian shall hold office at the pleasure of the Library Commission.

Should proposition "E" be enacted, a position of Assistant City Librarian would be created. Based on information furnished by the Secretary of the Library Commission, it is estimated that the cost of government of the City and County of San Francisco will increase by \$11,593 annually. Based on the 1960-1961 assessment roll, \$11,593 is equivalent to one tenth of one cent (\$0.001) in the tax rate.

HARRY D. ROSS, Controller  
City and County of San Francisco

## CHARTER AMENDMENT PROPOSITION F

**Amends Charter Section 42 and adds sections 42.1, 42.2, 42.3 and 42.4. Transfers engineering functions and personnel of Recreation and Park Department to Public Works Department. Renumbers sections.**

Describing and setting forth a proposal to the qualified electors of the City and County of San Francisco to amend the Charter of the said city and county by amending section 42 thereof and adding sections 42.1, 42.2, 42.3 and 42.4, relating to the Recreation and Park Commission.

The Board of Supervisors of the City and County of San Francisco hereby submits to the qualified electors of said city and county at an election to be held therein on November 8, 1960, a proposal to amend the Charter of said city and county by amending section 42 thereof and adding sections 42.1, 42.2, 42.3 and 42.4, so that the same shall read as follows:

NOTE: Additions or substitutions are indicated by **bold-face type**; deletions are indicated by ((double parentheses)).

((Control and Use of Property-Tax Levy))

Section 42. ((The recreation and park commission shall have the complete and exclusive control, management and direction of the parks, playgrounds, recreation centers and all other recreation facilities, squares, avenues and grounds which are in the charge of either of said commissions on the effective date hereof, or are thereafter placed in the charge of this commission, including exclusive power to erect and to superintend the erection of buildings and structures thereon, and to construct new parks, squares, playgrounds and recreation centers, except as in this charter otherwise provided.

((It shall be the policy of the commission to promote and foster a program providing for organized public recreation of the highest standard.

((The commission, through the general manager, shall utilize the property under its control and organize the personnel under its direction, to the end that all functions of the department be performed with the greatest possible efficiency.

((The San Francisco Unified School District shall supervise and direct recreational activities in facilities under its jurisdiction, and the commission and the school district shall have the power to supervise and direct other adjacent recreational and park facilities either jointly or severally by agreement.

((The commission shall not lease any part of the lands under its control nor permit the building or maintenance or use of any structure on any park, square, avenue or ground, except for recreation purposes, and each letting or permit shall be subject to the approval of the board of supervisors by ordinance, but the commission may lease to the highest responsible bidder for a term of not to exceed fifty years and upon such other terms and conditions as it may determine, subsurface space under any public park or square and the right and privilege to conduct and operate therein a public automobile parking station, provided that the said construction, when completed, and the operation will not be, in any material respect or

degree, detrimental to the original purpose for which said park or square was dedicated or in contravention of the conditions of any grant under which said park or square might have been received. The revenues derived from any such lease shall be credited to the recreation and park department fund.

((The recreation and park commission shall have the power to lease or rent any stadium or recreation field under its jurisdiction for athletic contests, exhibitions and other special events and may permit the lessee to charge an admission fee.

((The amount of money to be provided by tax levy for recreation and park purposes shall not be less than the total of the amounts now or hereafter provided for parks and squares and for playgrounds under the provisions of section 78 of this charter.))

The recreation and park commission shall have the complete and exclusive control, management and direction of the parks, playgrounds, recreation centers and all other recreation facilities, squares, avenues and grounds which are in the charge of the commission on the effective date hereof, or are thereafter placed in the charge of the commission, except as in this charter otherwise provided.

It shall also have power to construct new parks, playgrounds, recreation centers, recreation facilities, squares and grounds, and to erect and maintain buildings and structures on parks, playgrounds, squares, avenues and grounds, provided that all plans, specifications and estimates in connection therewith shall be prepared by the department of public works and be subject to approval by the recreation and park commission.

All contracts or orders for the work to be performed under such plans and specifications shall be awarded and executed by the director of public works with the approval of the recreation and park commission and shall be administered by the director of public works.

It shall be the duty of the recreation and park commission to make provision for the funds required for the operation and continuance of the duties herein assigned to the department of public works.

The persons performing the functions and duties transferred from the recreation and park department to the department of public works shall be transferred therewith, and such employees shall retain in the department of public works the same salary and civil service seniority status as they had in the recreation and park department.

Section 42.1. It shall be the policy of the commission to promote and foster a program providing for organized public recreation of the highest standard.

The commission, through the general manager, shall utilize the property under its control and organize the personnel under its direction, to the end that all functions of the department be performed with the greatest possible efficiency.

The San Francisco Unified School District shall supervise and direct recreational activities in facilities under its jurisdiction, and the commission and the school district shall have the power to supervise and direct other adjacent recreation and park facilities either jointly or severally by agreement.

Section 42.2. Except as provided in section 42.3, the commission shall not lease any part of the lands under its control nor permit the building or maintenance or use of any structure on any park, square, avenue or ground, except for recreation purposes, and each letting or permit

shall be subject to approval of the board of supervisors by ordinance. The commission may lease to the highest responsible bidder for a term of not to exceed fifty years and upon such other terms and conditions as it may determine, subsurface space under any public park or square and the right and privilege to conduct and operate therein a public automobile parking station, provided that the said construction, when completed, and the operation will not be, in any material respect or degree, detrimental to the original purpose for which said park or square was dedicated or in contravention of the conditions of any grant under which said park or square might have been received. The revenues derived from any such lease shall be credited to the recreation and park department fund.

Section 42.3. The recreation and park commission shall have the power to lease or rent any stadium or recreation field under its jurisdiction for athletic contests, exhibitions and other special events and may permit the lessee to charge an admission fee.

Section 42.4. The amount of money to be provided by tax levy for recreation and park purposes shall not be less than the total of the amounts now or hereafter provided for parks and squares and for playgrounds under the provisions of section 78 of this charter.

Ordered submitted — Board of Supervisors, San Francisco, September 6, 1960.

Ayes: Supervisors Blake, Casey, Dobbs, Ertola, Ferdon, McMahon, Rolph, J. Joseph Sullivan, James J. Sullivan, Zirpoli.

I hereby certify that the foregoing charter amendment was ordered submitted by the Board of Supervisors of the City and County of San Francisco.

ROBERT J. DOLAN, Clerk

### ARGUMENT FOR PROPOSITION "F"

The purpose of this Proposition is to transfer all engineering functions of the Recreation and Park Department (Commission) to the centralized agency of the Department of Public Works. The Department of Public Works is best organized to perform engineering service and more adequately staffed to carry out these duties in the most efficient and economical manner.

As a result of this centralization of engineering activities, previously performed by the Recreation and Park Department, within the Department of Public Works, the preparation of plans and specifications of construction work related to recreation and park activities will be done in an expeditious manner best designed for the interests of the citizens of the City and County of San Francisco.

The Recreation and Park Commission will continue to have authority to approve all plans and specifications for recreation and park facilities prepared by the Department of Public Works.

A vote for Proposition "F" is a vote for efficiency and economy.

WALTER A. HAAS,

President, Recreation and Park Commission.

On September 6, 1960, the Board of Supervisors authorized the foregoing argument for inclusion in the election pamphlet for November 8, 1960, by the following vote:

Ayes: Supervisors Blake, Casey, Dobbs, Ertola, Ferdon, McMahon, Rolph, J. Joseph Sullivan, James J. Sullivan, Zirpoli.

ROBERT J. DOLAN, Clerk

## CHARTER AMENDMENT PROPOSITION G

**Adds Section 165.5.1 to Charter. Provides percentage increase in that part of the retirement allowance which does not exceed \$200 per month of persons who retired under Section 165.2 prior to July 1, 1959.**

Describing and setting forth a proposal to the qualified electors of the City and County of San Francisco to amend the charter of said city and county by adding Section 165.5.1 thereto, to provide for an increase in retirement allowances to persons retired pursuant to Section 165.2 of the charter prior to July 1, 1959.

The Board of Supervisors of the City and County of San Francisco hereby submits to the qualified electors of said city and county at an election to be held therein on November 8, 1960, a proposal to amend the charter of said city and county by adding Section 165.5.1 thereto, reading as follows:

Section 165.5.1. (1) Every monthly allowance, excluding the annuity provided by additional contributions, which is payable under the San Francisco City and County Employees' Retirement System, for time commencing on the effective date of this section, hereby designated as the first day of the month next following its ratification by the Legislature, to or on account of any member who was retired as a member under Section 165.2 of the charter, prior to July 1, 1959, is hereby increased subject to the last sentence in this paragraph, by an amount derived by applying the percentage set forth in the following table opposite the period during which the member's retirement became effective to so much of the allowance, after such exclusion and prior to modification under an option provided by ordinance, which does not exceed \$200.00:

Period during which retirement became effective	Percentage of increase in monthly allowance
Prior to July 1, 1950 .....	11.7
48 months ended June 30, 1954 .....	11.6
12 months ended June 30, 1955 .....	10.0
12 months ended June 30, 1956 .....	8.0
12 months ended June 30, 1957 .....	6.0
12 months ended June 30, 1958 .....	4.0
12 months ended June 30, 1959 .....	2.0

If any such member elected at his retirement to receive his allowance under option two or three, as provided by ordinance, and if at the effective date of this section, both such member and the beneficiary named by him under such option are living, or only the beneficiary is living, but not otherwise, such increase shall be modified under the option elected at retirement, and on the basis of ages calculated as of said effective date, and current mortality tables and interest rate.

(2) Contributions to the Retirement System necessary for the payment of said increases shall be paid to the System by the city and county by annual appropriations, provided that such appropriation for any year

shall not be less than the amount disbursed during that year on account of said increases.

(3) This section does not give any retired member, or his successors in interest, or his beneficiary, or any payee for any allowance in respect to a deceased member, any claim against the city for any increase in any allowance paid or payable for time prior to its effective date.

Ordered submitted — Board of Supervisors, San Francisco, September 6, 1960.

Ayes: Supervisors Blake, Casey, Dobbs, Ertola, Ferdon, McMahon, Rolph, J. Joseph Sullivan, James J. Sullivan, Zirpoli.

I hereby certify that the foregoing charter amendment was ordered submitted by the Board of Supervisors of the City and County of San Francisco.  
ROBERT J. DOLAN, Clerk.

## ARGUMENT FOR PROPOSITION "G"

### Say "Yes" to our Aged Employees

In simple language Proposition "G" provides a reasonable adjustment of the pension allowance for retired miscellaneous employees and teachers of the City and County of San Francisco. It corrects to some extent, the unforeseen economic injustices of the original Retirement Act of 1947 caused by continuing inflation.

The facts in support of this amendment cannot be denied, to wit:

1. Present retirement allowances of 32% of those affected now range from \$3.52 to \$99 per month.
2. The maximum benefit is \$23.40 per month. Only 53 persons out of the 2,625 affected by this amendment (which does not include Police or Firemen) will receive this maximum, all of whom have retired prior to July 1, 1950. Other benefits will be proportionately lower.
3. No pension allowance increase has been granted to any of this group who have retired since July, 1952.
4. It affects only those presently retired since 1947. It does not and will not affect present or future employees.
5. None of the persons affected were eligible to participate in the Federal Social Security program extended by the city to the present employees in 1959.
6. The cost of living has increased from 1946 to 1959 by 54%. The plight of this neglected and forgotten group of aging and aged civil employees is obvious. They are trying to live on a 1947 dollar in a 1960 economy.

### Others Have Fared Better

The United States Government has increased pensions of its employees four times since 1948, Federal Social Security has increased benefits four times since 1940, the latest a 7% increase in 1959.

The State of California increased the pension allowances of its retired employees in 1955 and 1957.

California State Old Age Assistance has increased benefits more than 100% since 1947.

Other California Cities and Counties have granted pension increases to their employees.



The cost of this amendment will only be a few cents a year to each taxpayer. The dividend to this group, in many instances, will mean the difference between existing and living.

Say "Yes" to our Aged Employees. Vote "Yes" on Proposition "G."

This amendment is sponsored by the Retired Employees of the City and County of San Francisco.

L. B. PERINONI, President  
IVAN FLAMM  
G. M. KLINGNER

Endorsed by:

San Francisco Labor Council, AFL-CIO

George W. Johns, Secretary—S. F. Labor Council, AFL-CIO

International Organization of Masters, Mates and Pilots, Inc.

Civil Service Association

Retirement League of San Francisco

San Francisco Building and Construction Trades Council

A. F. Mailloux, Secretary—S. F. Building and Construction Trades Council

Central Council of Civic Clubs

On September 6, 1960, the Board of Supervisors authorized the foregoing argument for inclusion in the election pamphlet for November 8, 1960, by the following vote:

Ayes: Supervisors Blake, Casey, Dobbs, Ertola, Ferdon, McMahon, Rolph, J. Joseph Sullivan, James J. Sullivan, Zirpoli.

ROBERT J. DOLAN, Clerk

### ARGUMENT AGAINST PROPOSITION "G"

Vote "No" on Proposition "G" Another Patchwork Pension Proposal

Voters must reject this proposal which involves another costly pension increase for retired employees. The cost of this measure, which would give 2,600 retired city employees percentage increases in allowances, is \$3,374,508 which, with interest, would total \$4,240,065 if financed over 15 years, all at public expense.

Proposition "G" sets a precedent which will likely bring more costly pension grants before the voters. In addition to this group there are 1,000 retired under the old pension system and 730 retired policemen and firemen who could come in for equal percentage increases. Future retired workers are also likely to want percentage adjustments of this kind.

Although the amounts of increase appear modest, the largest grants would go to those who have already received a \$25 increase voted in 1956.

Don't be misled by the argument that 32% of these people get from \$3.52 to \$99 a month. It is just as accurate to say that 26% receive from \$200 to \$600 a month. Anyone getting a \$3.52 pension worked only a short time and the city has no obligation to provide all his pension needs.

For these reasons we ask that you vote "NO" on Proposition "G", a costly pension grant that will lead to other proposals of this type.

This argument is sponsored by The San Francisco Municipal Conference, composed of representatives of the following organizations:

Apartment House Associations  
Consolidated, Inc.

Building Owners and Managers  
Association

California Northern Hotel  
Association

Down Town Association

San Francisco Chamber of Commerce

S. F. Junior Chamber of Commerce

San Francisco Real Estate Board

ARTHUR E. WILKENS, Chairman

**CONTROLLER'S STATEMENT PURSUANT TO CHARTER SECTION 183  
PROPOSITION "G"**

**Charter amendment, adding section 165.5.1 thereto, to provide for an increase in retirement allowances to persons retired pursuant to section 165.2 of the charter prior to July 1, 1959.**

Should proposition "G" be enacted, in the judgment of this office, which is based on a report prepared by the San Francisco Employees Retirement System, the increase in the annual cost of government of the City and County of San Francisco, if the total cost is funded over a period of fifteen years, is estimated to be \$282,671.00.

In my opinion, based on the 1960-61 assessment roll, \$275,211.00 of the above average annual cost will have to be financed from ad valorem taxes and is equivalent to one and nine tenths (\$.019) cents in the tax rate annually for fifteen years.

HARRY D. ROSS, Controller  
City and County of San Francisco

**PROPOSITION H**

**An ordinance authorizing, subject to certain conditions, the sale of land, improvements and water rights to the City of Pleasanton.**

FILE No. 594-60-2

ORD. No. 447-60

**ORDERING SUBMISSION OF ORDINANCE AUTHORIZING AN AGREEMENT OF SALE AND THE SALE OF LAND, IMPROVEMENTS AND WATER RIGHTS TO THE CITY OF PLEASANTON SUBJECT TO CONDITIONS RELATING THERETO.**

The Board of Supervisors hereby orders submitted to the qualified electors of the City and County of San Francisco, at an election to be held therein on November 8, 1960 an ordinance authorizing the sale of part of a public utility to the City of Pleasanton, as follows:

**ORDINANCE No. 446-60**

**AN ORDINANCE AUTHORIZING AN AGREEMENT OF SALE AND THE SALE OF LAND, IMPROVEMENTS AND WATER RIGHTS TO THE CITY OF PLEASANTON SUBJECT TO CONDITIONS RELATING THERETO.**

Be it ordained by the People of the City and County of San Francisco:  
Section 1. The Mayor and the Clerk of the Board of Supervisors are hereby authorized on behalf of the Board of Supervisors to enter into an Agreement of Sale and to sell to the City of Pleasanton for the sum of Forty Thousand (\$40,000) Dollars all its right, title and interest in and to

that certain parcel of real property at Black Avenue and Santa Rita Road, near Pleasanton in Alameda County, approximately three-tenths of an acre in extent, with the wells and other improvements thereon and the pipelines appurtenant thereto, used exclusively to supply water to the City of Pleasanton, and also with such water rights as San Francisco may own to withdraw water from the subterranean basin in the Amador Valley, near Pleasanton, for use beyond the limits of said valley. The said Agreement of Sale and sale shall be subject to a reservation of the right to withdraw water from said subterranean basin for domestic, industrial, agricultural or municipal uses on any lands now owned or hereafter acquired in fee by San Francisco within the boundaries of the Pleasanton Township County Water District, on lands now being supplied by San Francisco and known as "Oakmead Farm," on lands now being supplied by San Francisco formerly known as the "Phoebe A. Hearst Ranch," and as a supplemental source of supply to Pleasanton, on any lands now or hereafter served by the Pleasanton water system.

Section 2. The transfer of said water rights to Pleasanton shall be subject to the assumption and performance by Pleasanton of certain contractual obligations to third parties of the Spring Valley Water Company which were assumed by San Francisco by deed dated March 3, 1930, transferring Spring Valley Water Company properties to San Francisco, to the extent that such obligations arise after July 1, 1960.

Section 3. The transfer of said water rights to Pleasanton also shall be subject to a release and discharge by Pleasanton of any and all obligations of San Francisco to Pleasanton based on contractual obligations of the Spring Valley Water Company to Pleasanton and assumed by San Francisco by said 1930 deed.

Section 4. The said Agreement of Sale and any deed or deeds executed to accomplish performance of the Agreement of Sale may contain such other terms and conditions not inconsistent with the provisions of this ordinance as are necessary for the purpose of carrying out the objects and purposes of this ordinance.

**Passed for Second Reading — Board of Supervisors, San Francisco, August 29, 1960.**

Ayes: Supervisors Blake, Casey, Dobbs, Ertola, Ferdon, Halley, McMahon, J. Joseph Sullivan, James J. Sullivan, Zirpoli.

ROBERT J. DOLAN, Clerk

**Read Second Time and Finally Passed — Board of Supervisors, San Francisco, September 6, 1960.**

Ayes: Supervisors Blake, Casey, Dobbs, Ertola, Ferdon, McMahon, Rolph, J. Joseph Sullivan, James J. Sullivan, Zirpoli.

I hereby certify that the foregoing ordinance was finally passed by the Board of Supervisors of the City and County of San Francisco.

ROBERT J. DOLAN, Clerk

Approved: September 8, 1960.

GEORGE CHRISTOPHER, Mayor

## **ARGUMENT FOR PROPOSITION "H"**

### **Explanation of Proposition "H," authorizing sale of Water Department property and water rights to the City of Pleasanton for \$40,000.**

Proposition "H," submitted to the voters as required by Charter Section 123, authorizes the sale to the City of Pleasanton of the following property in southern Alameda County for \$40,000: Two wells, the 0.3-acre parcel of property on which the wells are located, and 2,597 lineal feet of 10-inch pipe, all of which are used exclusively to supply water to Pleasanton.

The \$40,000 represents the full value of the property and improvements involved in the sale. Also included in the sale are water rights which have become an expensive burden to San Francisco over the years.

Before 1934, wells tapping the surplus water in the gravel deposits underlying the Pleasanton area were an important source of water for export to San Francisco and the Peninsula. During the last 26 years, however, San Francisco has exported no water from this area except for a 15-month period in 1948 and 1949.

Indeed, the population of the Pleasanton area and their use of water have so increased that the gravel basin is now overdrawn. Yet San Francisco—saddled by ancient Spring Valley Water Company agreements dating back to 1916—pays more than \$35,000 annually to maintain the "right" to export surplus water even though no surplus water is available for export.

Thus, the sale of the property and rights will relieve San Francisco of a costly annual expenditure for which it receives no useful benefits in return, and will greatly aid in the growth and development of the City of Pleasanton by providing that community with the control of the water used in its area.

On September 6, 1960, the Board of Supervisors authorized the foregoing argument for inclusion in the election pamphlet for November 8, 1960, by the following vote:







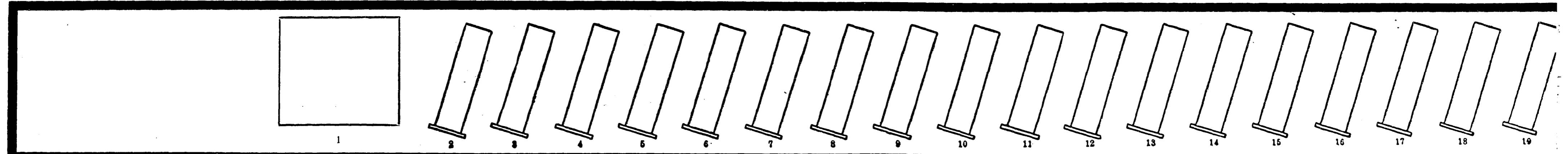

Ayes: Supervisors Blake, Casey, Dobbs, Ertola, Ferdon, McMahon, Rolph, J. Joseph Sullivan, James J. Sullivan, Zirpoli.









**ROBERT J. DOLAN, Clerk**

# 21 SAMPLE BALLOT







# GENERAL ELECTION

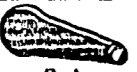
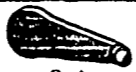

 <p>PROPOSITION <b>FOR 1 AGAINST</b></p> <p>THE CALIFORNIA WATER RESOURCES DEVELOPMENT BOND ACT. This act provides for a bond issue of one billion, seven hundred fifty million dollars (\$1,750,000,000) to be used by the Department of Water Resources for the development of the water resources of the State.</p>	 <p>PROPOSITION <b>YES 2 NO</b></p> <p>TERMS OF ASSEMBLYMEN. Provides terms of four years for members of Assembly with terms staggered so that half are elected every two years.</p>	 <p>PROPOSITION <b>YES 3 NO</b></p> <p>DISABLED VETERANS' TAX EXEMPTION. Permits totally disabled veteran entitled to \$5,000 exemption on home to transfer it to subsequently acquired home.</p>	 <p>PROPOSITION <b>YES 4 NO</b></p> <p>TERMS OF OFFICE. Permits Legislature to provide terms up to eight years for members of agency administering State College System.</p>	 <p>PROPOSITION <b>YES 5 NO</b></p> <p>COMPENSATION OF LEGISLATORS. Sets salary of State legislators at \$750 per month without increasing retirement benefits for legislators already retired.</p>	 <p>PROPOSITION <b>YES 6 NO</b></p> <p>ASSESSMENT OF GOLF COURSES. Establishes manner in which non-profit golf courses should be assessed for purposes of taxation.</p>	 <p>PROPOSITION <b>YES 7 NO</b></p> <p>CHIROPRACTORS. Permits two board members to be from same chiropractic school; provides that Legislature may fix fees of licensees and compensation of board members.</p>	 <p>PROPOSITION <b>YES 8 NO</b></p> <p>ELIGIBILITY TO VOTE. Changes prohibitions of eligibility to vote from those convicted of infamous crime to those convicted of felony during punishment therefor and those convicted of treason.</p>
---	---	---	---	--	--	--	---

 <p>PROPOSITION <b>YES A NO</b></p> <p>Sewer Bonds, 1960. To incur a bonded indebtedness in the sum of \$12,500,000 for the acquisition, construction and completion of buildings, lands, structures, and all other works, properties and appurtenances necessary or useful for sewage collection and disposal.</p>	 <p>PROPOSITION <b>YES B NO</b></p> <p>Repeals Charter Section 5.1. Eliminates limitation of two successive terms for any one person to serve as Mayor.</p>	 <p>PROPOSITION <b>YES C NO</b></p> <p>Amends Charter Sections 9 and 25. Provides method of succession in event of disaster for office of Mayor, grants Board of Supervisors powers conferred by State law pertaining to preservation of local government.</p>	 <p>PROPOSITION <b>YES D NO</b></p> <p>Adds Sections 165.5 and 168.4 to Charter. Provides for periodic adjustment in retirement allowance in direct proportion to changes in the earnable salaries of members.</p>	 <p>PROPOSITION <b>YES E NO</b></p> <p>Amends Charter Section 43. Provides for appointment by Library Commission of Assistant Librarian to serve at its pleasure. Repeals obsolete language.</p>	 <p>PROPOSITION <b>YES F NO</b></p> <p>Amends Charter Section 42 and adds sections 42.1, 42.2, 42.3 and 42.4. Transfers engineering functions and personnel of Recreation and Park Department to Public Works Department. Renumber sections.</p>	 <p>PROPOSITION <b>YES G NO</b></p> <p>Adds Section 165.5.1 to Charter. Provides percentage increase in that part of the retirement allowance which does not exceed \$200 per month of persons who retired under Section 165.2 prior to July 1, 1959.</p>	 <p>PROPOSITION <b>YES H NO</b></p> <p>An ordinance authorizing, subject to certain conditions, the sale of land, improvements and water rights to the City of Pleasanton.</p>
--	--	--	---	---	---	--	---

<p><b>PRESIDENTIAL ELECTORS</b> Vote for ONE Party</p>			<p>16 <b>REPRESENTATIVE IN CONGRESS</b> 4th District VOTE FOR ONE</p>	<p>17 <b>MEMBER OF ASSEMBLY</b> 21st District VOTE FOR ONE</p>	<p>18 <b>MEMBER OF ASSEMBLY</b> 21st District VOTE FOR ONE</p>	<p>19 <b>MEMBER OF ASSEMBLY</b> 21st District VOTE FOR ONE</p>	<p>20 <b>ASSOCIATE SUPREME COURT JUSTICE</b> VOTE FOR ONE</p>
--	--	--	---	--	--	--	---

 3-A <b>RICHARD M. NIXON</b> <b>HENRY CABOT LODGE</b> REPUBLICAN <p style="text-align: right;">for President for Vice President</p>	 8-A <b>RUTHERFORD L. DECKER</b> <b>E. HAROLD MUNN</b> PROHIBITION <p style="text-align: right;">for President for Vice President</p>	 13-A <b>JOHN F. KENNEDY</b> <b>LYNDON B. JOHNSON</b> DEMOCRATIC <p style="text-align: right;">for President for Vice President</p>	 16-A <b>William S. Mailliard</b> Republican U. S. Congressman <p style="text-align: right;">for President</p>	 17-A <b>Phillips S. (Phil) Davies</b> Democratic Investment Counsellor <p style="text-align: right;">for President</p>	 18-A <b>Milton Marks</b> Republican Incumbent <p style="text-align: right;">for President</p>	 19-A <b>George R. Moscone</b> Democratic Attorney at Law <p style="text-align: right;">for President</p>	 20-A <b>YES</b> <b>Maurice</b> be elected to term presi <p style="text-align: right;">for President</p>
--	--	--	---	--	---	--	---

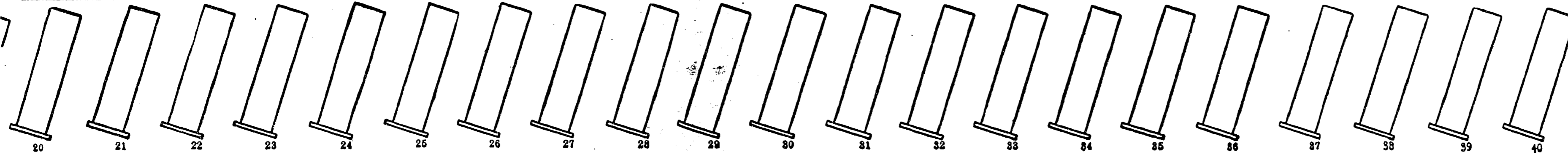

<p>PROPOSITION 9</p> <p>YES NO</p> <p>CLAIMS AGAINST CHARTERED CITIES AND COUNTIES. Permits Legislature to prescribe procedures governing claims against chartered counties, cities and counties, and cities, or their employees.</p>	<p>PROPOSITION 10</p> <p>YES NO</p> <p>ADMINISTRATION OF JUSTICE. Broadens membership of Judicial Council to include members of Bar and legislators; creates Commission on Judicial Qualifications; provides procedure for removal of judges.</p>	<p>PROPOSITION 11</p> <p>YES NO</p> <p>VETERANS' TAX EXEMPTION. Changes residency requirements for \$1,000 exemption; restricts survivors' exemptions; extends exemptions to widowers and to any home subsequently acquired by totally disabled veteran.</p>	<p>PROPOSITION 12</p> <p>YES NO</p> <p>CONSTITUTION. Eliminates obsolete and superseded provisions without substantive change or effect. Does not affect prior validations or other propositions affecting same sections.</p>	<p>PROPOSITION 13</p> <p>YES NO</p> <p>DISTRICT COURTS OF APPEAL: APPELLATE JURISDICTION. Provides District Courts of Appeal shall have appellate jurisdiction of municipal and justice court cases as provided by law.</p>	<p>PROPOSITION 14</p> <p>YES NO</p> <p>STREET AND HIGHWAY FUNDS: USE FOR LOCAL GRADE CROSSING BONDS. Provides 50% of State highway funds allocated to local agencies may be used for grade crossing projects.</p>	<p>PROPOSITION 15</p> <p>YES NO</p> <p>SENATE REAPPORTIONMENT. Apportions 40 senatorial districts; permits Legislature to reapportion after 1980 census provided that 20 districts be apportioned to 13 designated counties and 20 districts to remaining 45 counties.</p>
---	---	--	---	---	---	--

## STATE PROPOSITIONS

## CITY & COUNTY PROPOSITIONS

### DIRECTIONS FOR VOTING

1. Move **RED HANDLE LEVER** of voting machine to the **RIGHT** as far as it will go and **LEAVE IT THERE**.
2. To vote **FOR** or **AGAINST** propositions or **FOR** or **AGAINST** confirmation of member of Board of Education, or **FOR** or **AGAINST** Justices of the Supreme Court and District Court of Appeal, pull down pointers over words indicating your choice and **LEAVE THEM DOWN**.
3. To vote for all of the electors of a party pull down the pointer over the names of the presidential and vice-presidential candidates of that party and **LEAVE IT DOWN**.
4. To vote **FOR** candidate for Representative in Congress, Member of Assembly and Judge of the Superior Court, pull down pointer over the name of your choice and **LEAVE IT DOWN**.

5. To vote for those electors who have pledged themselves to vote for a candidate for President and for Vice President of any party not qualified to participate in the election, write in the names and party of those presidential and vice presidential candidates in the blank space provided for that purpose in the upper left hand corner of the machine — under square slide #1.
6. To vote for a person whose name does not appear on the ballot label card, **RAISE NUMBERED SLIDE AT TOP OF MACHINE** corresponding to number of office on office title card, and **WRITE NAME** of candidate on paper under slide. **DO NOT** pull down pointer over name of any candidate in office group in which you intend to write in name of a candidate.
7. **LEAVE THE POINTERS DOWN** and move the **RED HANDLE LEVER** to the **LEFT** as far as it will go. Your vote is not registered until this is done.
8. If in doubt as to operating the voting machine, request instructions from the inspector or judge of the election board before attempting to vote.

STUDY SAMPLE  
BALLOT CAREFULLY.  
MARK YOUR CHOICES ON  
POLLING PLACE CARD.  
TAKE CARD TO POLLING  
PLACE.

POLLS OPEN 7 A.M. —  
CLOSE 8 P.M.

VOTE EARLY

21	22	23	24	25	26	27	28	29	30	31	32	33	34	35	36	37
ASSOCIATE JUSTICE, SUPREME COURT	ASSOCIATE JUSTICE, SUPREME COURT	ASSOCIATE JUSTICE, SUPREME COURT	PRESIDING JUSTICE, DISTRICT COURT OF APPEAL First Appellate District Division One	ASSOCIATE JUSTICE, DISTRICT COURT OF APPEAL First Appellate District Division One	ASSOCIATE JUSTICE, DISTRICT COURT OF APPEAL First Appellate District Division One	ASSOCIATE JUSTICE, DISTRICT COURT OF APPEAL First Appellate District Division Two	JUDGE OF THE SUPERIOR COURT Office No. 9 VOTE FOR ONE	MEMBER BOARD OF EDUCATION Nominated by Mayor for confirmation by Electors.								
21-A NO	22-A YES	23-A NO	24-A YES	25-A NO	26-A YES	27-A NO	28-A YES	29-A NO	30-A YES	31-A NO	32-A YES	33-A NO	34-A	35-A	36-A YES	37-A NO
Shall <b>T. Dooling, Jr.</b> be elected to the office for the term prescribed by law?	Shall <b>Raymond E. Peters</b> be elected to the office for the term prescribed by law?	Shall <b>Thomas P. White</b> be elected to the office for the term prescribed by law?	Shall <b>A. F. Bray</b> be elected to the office for the term prescribed by law?	Shall <b>Ben C. Duniway</b> be elected to the office for the term prescribed by law?	Shall <b>Mathew O. Tobriner</b> be elected to the office for the term prescribed by law?	Shall <b>Daniel R. Shoemaker</b> be elected to the office for the term prescribed by law?	<b>Joseph Karesh</b> U.S. Commissioner, Federal Court	<b>Lenore D. Underwood</b> Judge, Municipal Court							<b>Edward Kemmitt</b>	

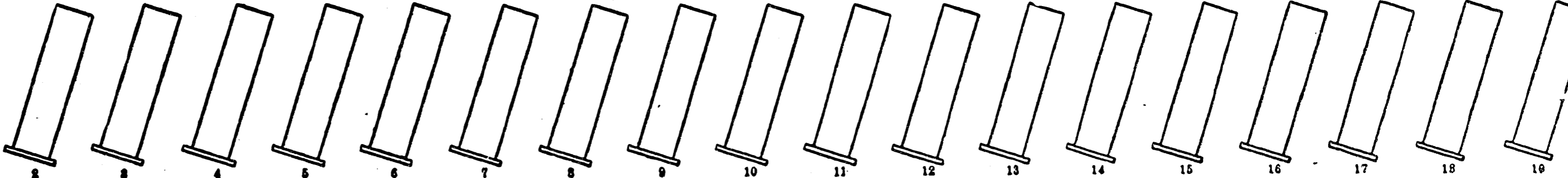
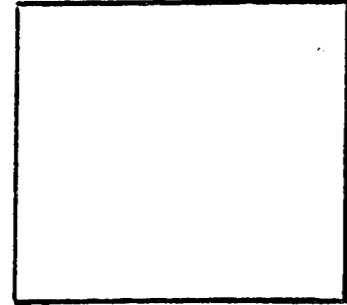

1

2

3

4

5

6

7

8

9

10

11

12

13

14

15

16

17

18

19

**PROPOSITION 1**  
**FOR 1 AGAINST**  
 THE CALIFORNIA WATER RESOURCES DEVELOPMENT BOND ACT. This act provides for a bond issue of one billion, seven hundred fifty million dollars (\$1,750,000,000) to be used by the Department of Water Resources for the development of the water resources of the State.

**PROPOSITION 2**  
**YES 2 NO**  
 TERMS OF ASSEMBLYMEN. Provides terms of four years for members of Assembly with terms staggered so that half are elected every two years.

**PROPOSITION 3**  
**YES 3 NO**  
 DISABLED VETERANS' TAX EXEMPTION. Permits totally disabled veteran entitled to \$5,000 exemption on home to transfer it to subsequently acquired home.

**PROPOSITION 4**  
**YES 4 NO**  
 TERMS OF OFFICE. Permits Legislature to provide terms up to eight years for members of agency administering State College System.

**PROPOSITION 5**  
**YES 5 NO**  
 COMPENSATION OF LEGISLATORS. Sets salary of State legislators at \$750 per month without increasing retirement benefits for legislators already retired.

**PROPOSITION 6**  
**YES 6 NO**  
 ASSESSMENT OF GOLF COURSES. Establishes manner in which non-profit golf courses should be assessed for purposes of taxation.

**PROPOSITION 7**  
**YES 7 NO**  
 CHIROPRACTORS. Permits two board members to be from same chiropractic school; provides that Legislature may fix fees of licensees and compensation of board members.

**PROPOSITION 8**  
**YES 8 NO**  
 ELIGIBILITY TO VOTE. Changes prohibitions of eligibility to vote from those convicted of infamous crime to those convicted of felony during punishment therefor and those convicted of treason.

**PROPOSITION A**  
**YES A NO**  
 Sewer Bonds, 1960. To incur a bonded indebtedness in the sum of \$12,500,000 for the acquisition, construction and completion of buildings, lands, structures, and all other works, properties and appurtenances necessary or useful for sewage collection and disposal.

**PROPOSITION B**  
**YES B NO**  
 Repeals Charter Section 5.1. Eliminates limitation of two successive terms for any one person to serve as Mayor.

**PROPOSITION C**  
**YES C NO**  
 Amends Charter Sections 9 and 25. Provides method of succession in event of disaster for office of Mayor, grants Board of Supervisors powers conferred by State law pertaining to preservation of local government.

**PROPOSITION D**  
**YES D NO**  
 Adds Sections 165.5 and 168.4 to Charter. Provides for periodic adjustment in retirement allowance in direct proportion to changes in the earnable salaries of members.

**PROPOSITION E**  
**YES E NO**  
 Amends Charter Section 43. Provides for appointment by Library Commission of Assistant Librarian to serve at its pleasure. Repeals obsolete language.

**PROPOSITION F**  
**YES F NO**  
 Amends Charter Section 42 and adds sections 42.1, 42.2, 42.3 and 42.4. Transfers engineering functions and personnel of Recreation and Park Department to Public Works Department. Renumbers sections.

**PROPOSITION G**  
**YES G NO**  
 Adds Section 165.5.1 to Charter. Provides percentage increase in that part of the retirement allowance which does not exceed \$200 per month of persons who retired under Section 165.2 prior to July 1, 1959.

**PROPOSITION H**  
**YES H NO**  
 An ordinance authorizing, subject to certain conditions, the sale of land, improvements and water rights to the City of Pleasanton.

3

8

13

16

17

18

19

20

## PRESIDENTIAL ELECTORS

Vote for ONE Party

**REPRESENTATIVE IN CONGRESS**  
 5th District  
 VOTE FOR ONE

**MEMBER OF ASSEMBLY**  
 24th District  
 VOTE FOR ONE

ASSOCI. SUPR

**3-A**  
**RICHARD M. NIXON** for President  
**HENRY CABOT LODGE** for Vice President  
 REPUBLICAN

**8-A**  
**RUTHERFORD L. DECKER** for President  
**E. HAROLD MUNN** for Vice President  
 PROHIBITION

**13-A**  
**JOHN F. KENNEDY** for President  
**LYNDON B. JOHNSON** for Vice President  
 DEMOCRATIC

**16-A**  
**John F. Shelley**  
 Democratic Member of Congress

**17-A**  
**Nick Verreos**  
 Republican Insurance Broker

**18-A**  
**Edward M. Gaffney**  
 Democratic Incumbent

**19-A**  
**Al Hicks**  
 Republican Proprietor, Small Business

**20-A**  
**YES**  
**Maurice** be elected term pres

# NOVEMBER 8, 1960

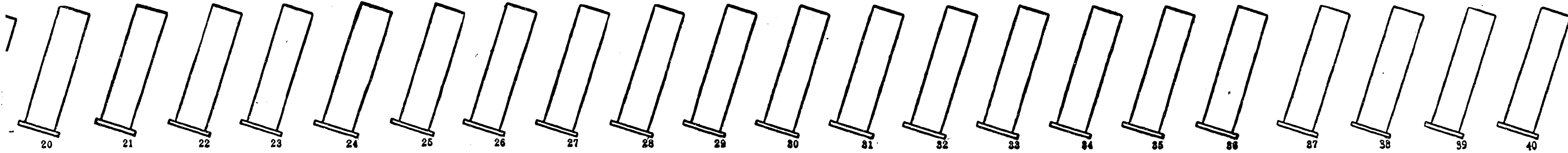

<p>PROPOSITION <b>YES 9 NO</b></p> <p>CLAIMS AGAINST CHARTERED CITIES AND COUNTIES. Permits Legislature to prescribe procedures governing claims against chartered counties, cities and counties, and cities, or their employees.</p>	<p>PROPOSITION <b>YES 10 NO</b></p> <p>ADMINISTRATION OF JUSTICE. Broadens membership of Judicial Council to include members of Bar and legislators; creates Commission on Judicial Qualifications; provides procedure for removal of judges.</p>	<p>PROPOSITION <b>YES 11 NO</b></p> <p>VETERANS' TAX EXEMPTION. Changes residency requirements for \$1,000 exemption; restricts survivors' exemptions; extends exemptions to widowers and to any home subsequently acquired by totally disabled veteran.</p>	<p>PROPOSITION <b>YES 12 NO</b></p> <p>CONSTITUTION. Eliminates obsolete and superseded provisions without substantive change or effect. Does not affect prior validations or other propositions affecting same sections.</p>	<p>PROPOSITION <b>YES 13 NO</b></p> <p>DISTRICT COURTS OF APPEAL: APPELLATE JURISDICTION. Provides District Courts of Appeal shall have appellate jurisdiction of municipal and justice court cases as provided by law.</p>	<p>PROPOSITION <b>YES 14 NO</b></p> <p>STREET AND HIGHWAY FUNDS: USE FOR LOCAL GRADE CROSSING BONDS. Provides 50% of State highway funds allocated to local agencies may be used for grade crossing projects.</p>	<p>PROPOSITION <b>YES 15 NO</b></p> <p>SENATE REAPPORTIONMENT. Apportions 40 senatorial districts; permits Legislature to reapportion after 1980 census provided that 20 districts be apportioned to 13 designated counties and 20 districts to remaining 45 counties.</p>
---	---	--	---	---	---	--

## STATE PROPOSITIONS

## CITY & COUNTY PROPOSITIONS

### DIRECTIONS FOR VOTING

1. Move **RED HANDLE LEVER** of voting machine to the **RIGHT** as far as it will go and **LEAVE IT THERE.**
2. To vote **FOR** or **AGAINST** propositions or **FOR** or **AGAINST** confirmation of member of Board of Education, or **FOR** or **AGAINST** Justices of the Supreme Court and District Court of Appeal, pull down pointers over words indicating your choice and **LEAVE THEM DOWN.**
3. To vote for all of the electors of a party pull down the pointer over the names of the presidential and vice-presidential candidates of that party and **LEAVE IT DOWN.**
4. To vote **FOR** candidate for Representative in Congress, Member of Assembly and Judge of the Superior Court, pull down pointer over the name of your choice and **LEAVE IT DOWN.**
5. To vote for those electors who have pledged themselves to vote for a candidate for President and for Vice President of any party not qualified to participate in the election, write in the names and party of those presidential and vice presidential candidates in the blank space provided for that purpose in the upper left hand corner of the machine — under square slide #1.
6. To vote for a person whose name does not appear on the ballot label card, **RAISE NUMBERED SLIDE AT TOP OF MACHINE** corresponding to number of office on office title card, and **WRITE NAME** of candidate on paper under slide. **DO NOT** pull down pointer over name of any candidate in office group in which you intend to write in name of a candidate.
7. **LEAVE THE POINTERS DOWN** and move the **RED HANDLE LEVER** to the **LEFT** as far as it will go. Your vote is not registered until this is done.
8. If in doubt as to operating the voting machine, request instructions from the inspector or judge of the election board before attempting to vote.

STUDY SAMPLE  
BALLOT CAREFULLY.  
MARK YOUR CHOICES ON  
POLLING PLACE CARD.  
TAKE CARD TO POLLING  
PLACE.  
POLLS OPEN 7 A.M. —  
CLOSE 8 P.M.  
VOTE EARLY

21	22	23	24	25	26	27	28	29	30	31	32	33	34	35	36	37
CLERK OF THE SUPREME COURT	ASSOCIATE JUSTICE, SUPREME COURT	ASSOCIATE JUSTICE, SUPREME COURT	PRESIDING JUSTICE, DISTRICT COURT OF APPEAL First Appellate District Division One	ASSOCIATE JUSTICE, DISTRICT COURT OF APPEAL First Appellate District Division One	ASSOCIATE JUSTICE, DISTRICT COURT OF APPEAL First Appellate District Division One	ASSOCIATE JUSTICE, DISTRICT COURT OF APPEAL First Appellate District Division Two	JUDGE OF THE SUPERIOR COURT Office No. 9 VOTE FOR ONE	MEMBER BOARD OF EDUCATION Nominated by Mayor for con- firmation by Electors.								
21-A NO	22-A YES	23-A NO	24-A YES	25-A NO	26-A YES	27-A NO	28-A YES	29-A NO	30-A YES	31-A NO	32-A YES	33-A NO	34-A	35-A	36-A YES	37-A NO
Shall <b>T. Dooling, Jr.</b> be elected to the office for the term prescribed by law?	Shall <b>Raymond E. Peters</b> be elected to the office for the term prescribed by law?	Shall <b>Thomas P. White</b> be elected to the office for the term prescribed by law?	Shall <b>A. F. Bray</b> be elected to the office for the term prescribed by law?	Shall <b>Ben C. Duniway</b> be elected to the office for the term prescribed by law?	Shall <b>Mathew O. Tobriner</b> be elected to the office for the term prescribed by law?	Shall <b>Daniel R. Shoemaker</b> be elected to the office for the term prescribed by law?	Lenore D. <b>Underwood</b> Judge, Municipal Court	Joseph <b>Karesh</b> U.S. Commissioner, Federal Court								